

2212 Access Utility



Introduction and Planning Guide

Note

Before using this information and the product it supports, be sure to read the general information under Appendix B, "Notices" on page B-1.

Third Edition (June 1999)

This edition applies to the IBM 2212 Access Utility and Access Integration Services Version 3.3.

Order publications through your IBM representative or the IBM branch office serving your locality. Publications are not stocked at the address given below.

Forms for readers' comments appear at the back of this publication. If the forms have been removed, address your comments to:

Department CGF
Design & Information Development
IBM Corporation
PO Box 12195
RESEARCH TRIANGLE PARK NC 27709-9990
USA

When you send information to IBM, you grant IBM a non-exclusive right to use or distribute the information in any way it believes appropriate without incurring any obligation to you.

© **Copyright International Business Machines Corporation 1998, 1999. All rights reserved.**
US Government Users Restricted Rights – Use, duplication or disclosure restricted by GSA ADP Schedule Contract with IBM Corp.

Contents

About This Guide	vii
Who Should Read This Guide	vii
How to Proceed	vii
Hardcopy Publications Shipped with the 2212	viii
Softcopy Publications Shipped on the CD-ROM	viii
Publications on the Internet	ix
Ordering IBM Publications	ix
Obtaining Updates and Corrections	ix
Summary of Changes	x
Chapter 1. Introduction to the 2212 Access Utility	1-1
Secure Virtual Private Networks (VPNs)	1-3
Voice Integration	1-6
Thin Server for High-Performance Thin Client Computing	1-8
Web Server Cache	1-9
IP-SNA Integration with TN3270E Server	1-10
Load Balancing with Network Dispatcher	1-11
General Multiprotocol Routing	1-12
SNA Transport	1-13
Serviceability	1-14
Remote Service Capability	1-15
Additional Warranty Information	1-16
Chapter 2. IBM 2212 Hardware and Adapters	2-1
Storage	2-3
Options	2-5
Cables	2-12
Chapter 3. IBM 2212 Network and Protocol Support	3-1
Networks Supported	3-1
Protocols and Features Supported	3-2
Framing Support	3-5
Chapter 4. Access Integration Services Software	4-1
Software Code Loads	4-2
Obtaining AIS	4-2
Chapter 5. Physical Planning and Prerequisites	5-1
Placement Options	5-1
Preparing the Machine Area	5-1
Physical Specifications	5-2
Performance	5-3
Power Supply	5-3
Hardware and Software Requirements for the Configuration Program	5-6
Tested Modems	5-7
Network Server Requirements	5-7
Chapter 6. Configuration and Monitoring Tools	6-1
Access Integration Services Configuration Program	6-1
OPCON	6-1

Service Recovery Interface	6-1
Bootstrap Menus	6-1
Network Management	6-2
Chapter 7. Network Planning	7-1
Planning for ISDN	7-1
Planning for Remote Access	7-4
Planning for Thin Server	7-5
Planning for Network Dispatcher	7-6
Planning for Virtual Private Networks	7-6
Appendix A. Initial Configuration Worksheet	A-1
Appendix B. Notices	B-1
Notice to Users of Online Versions of This Book	B-1
Glossary	X-1
Index	X-11

Tables

1-1.	Examples of Information Available Remotely from the Access Utility	1-15
2-1.	Comparing Models of the IBM 2212	2-2
2-2.	IBM 2212 Adapters, Feature Codes, and Part Numbers	2-5
3-1.	IBM 2212 Protocol and Feature Support	3-2
3-2.	IBM 2212 Protocol Support, by Interface	3-4
3-3.	IBM 2212 Framing Method Support	3-5
5-1.	AC Power Cords and Power Plug Standards	5-4
5-2.	Configuration Program Requirements for Supported Operating Systems	5-6
7-1.	Number of B-Channels per ISDN Adapter	7-1
A-1.	Initial Configuration Worksheet	A-2

About This Guide

This guide is meant to help you discover how the IBM 2212 Access Utility can contribute to the Internet, intranet, and extranet strategies of your network. If you have already purchased a IBM 2212, this book can help you plan for using it.

Who Should Read This Guide

While this guide provides technical details suitable for a network administrator planning a network design, it is also intended for the reader who intends to capitalize on networking technologies to solve general problems of business.

How to Proceed

For a general overview of the features that the IBM 2212 offers your business, see Chapter 1, "Introduction to the 2212 Access Utility" on page 1-1. The rest of the book is organized as follows:

- Chapter 2, "IBM 2212 Hardware and Adapters" on page 2-1 introduces the eight models of the IBM 2212 and illustrates the IBM 2212's integrated WAN connectivity. This chapter also lists the cables that you will need to order for each adapter.
- Chapter 3, "IBM 2212 Network and Protocol Support" on page 3-1 lists in detail the network and protocol support that the IBM 2212 offers.
- Chapter 4, "Access Integration Services Software" on page 4-1 explains the software features that the IBM 2212 supports.
- Chapter 5, "Physical Planning and Prerequisites" on page 5-1 helps you plan for physically installing a IBM 2212.
- Chapter 6, "Configuration and Monitoring Tools" on page 6-1 explains the configuration and monitoring tools that are available to help you access the IBM 2212.
- Chapter 7, "Network Planning" on page 7-1 helps you prepare to use IBM 2212 features such as Thin Server and integrated services digital network (ISDN).
- Appendix A, "Initial Configuration Worksheet" on page A-1 offers a short configuration worksheet to help you plan for router setup.

Hardcopy Publications Shipped with the 2212

These documents are shipped in hardcopy and are also contained on the *Access Integration Services Configuration Tool and Documentation* CD-ROM, SK2T-0435, in softcopy form:

Planning

GA27-4215 *2212 Access Utility Introduction and Planning Guide*

This book explains how the IBM 2212 fits into a network and what features and options it offers.

Installation

GA27-4216 *2212 Access Utility Installation and Initial Configuration Guide*

This booklet explains how to set up the IBM 2212, perform initial configuration, and correct some problems that might occur during installation.

GX27-4048 *2212 Access Utility Hardware Configuration Quick Reference*

This reference card is used for entering and saving configuration information such as IP and MAC addresses.

Configuration

GC30-3830 *Configuration Program User's Guide*

This book discusses how to use the Access Integration Services Configuration Program.

Diagnostics and Maintenance

GY27-0362 *2212 Access Utility Service and Maintenance Manual*

This book provides instructions for diagnosing problems with and repairing the IBM 2212.

Safety

SD21-0030 *Caution: Safety Information—Read This First*

This book provides translations of caution and danger notices applicable to the installation and maintenance of an IBM 2212.

Softcopy Publications Shipped on the CD-ROM

The following list shows the books that support the Access Integration Services program. They are shipped with the IBM 2212 on the *Access Integration Services Configuration Tool and Documentation* CD-ROM, SK2T-0435. Hardcopy versions of the books can be purchased separately.

Operations and Network Management

SC30-3988 *Access Integration Services Software User's Guide*

This book explains how to use the IBM 2212 command-line user interface to configure and monitor the network interfaces and link-layer protocols shipped with the IBM 2212.

SC30-3989 *Access Integration Services Using and Configuring Features*

This book explains how to configure and monitor features of the IBM 2212 such as bandwidth reservation, WAN restoration, and WAN reroute.

SC30-3990 *Access Integration Services Protocol Configuration and Monitoring Reference, Volume 1*

SC30-3991 *Access Integration Services Protocol Configuration and Monitoring Reference, Volume 2*

These books describe how to access and use the Access Integration Services command-line user interface to configure and monitor the routing protocol software shipped with the product.

They include information about each of the protocols that the device supports.

SC30-3682 *Event Logging System Messages Guide*

This book contains a listing of the error codes that can occur, along with descriptions and recommended actions to correct the errors.

Publications on the Internet

The publications that ship in hardcopy and CD-ROM are also available on the World Wide Web at:

<http://www.ibm.com/networking/support/docs.nsf/2212docs>

Ordering IBM Publications

In the U.S.A., you can order IBM publications by calling 1 800 879-2755. Within or outside the U.S.A., you can order IBM publications through the IBM Publications Direct Catalog on the World Wide Web at:

<http://www.elink.ibm.com/pbl/pbl>

IBM translates many publications into a variety of languages. The publication you need may be available in your language.

Obtaining Updates and Corrections

You can obtain updated versions of the software and product information from IBM's Web pages.

Documentation updates are at:

<http://www.ibm.com/networking/support/docs.nsf/2212docs>

Software updates are at:

<http://www.ibm.com/networking/support/downloads/2212>

Product information and updates are at:

<http://www.networking.ibm.com/2212/2212prod.html>

Summary of Changes

Changes to the IBM 2212 hardware publications include details about:

- The IBM 2212 Models x5x
- the high-performance system card
- 4-port 56K analog modem
- compression/encryption CPCI adapter
- 4-port WAN PMC adapter
- 2-port analog voice CPCI adapters
- T1/J1 and E1 digital modems

Chapter 1. Introduction to the 2212 Access Utility

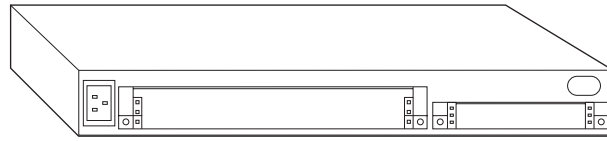

Figure 1-1. The IBM 2212 Access Utility, Models 1xx

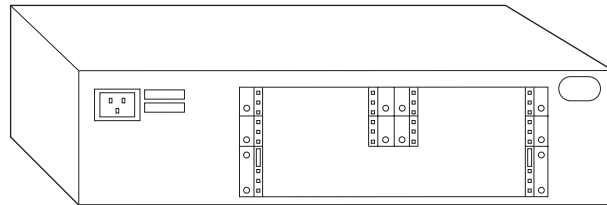

Figure 1-2. The IBM 2212 Access Utility, Models 4xx

An affordable, scalable solution for medium-sized business environments, IBM's new 2212 Access Utility offers standards-based virtual private network (VPN) services for secure Internet transactions, voice integration features that can reduce costs associated with intracompany telephone calls and faxes, integrated Thin Server support for high-performance thin client computing, and dial-in LAN access for the remote workforce. Designed to satisfy current and emerging requirements, the IBM 2212 provides:

- A choice between two system cards. The standard system card provides 128 MB of memory, while the faster, high-performance system card supports up to 512 MB of memory.
- Comprehensive, multiprotocol routing including IP version 6 (IPv6)¹
- Advanced data transport features for SNA environments
- Expansive legacy protocol support including tunneled Binary Synchronous (BSC) support
- Wide-ranging connectivity options, including 10/100-Mbps Ethernet
- Secure virtual private network services over the IPSec protocol
- Voice features that integrate into existing data network infrastructures and can reduce the cost of intra-company telephone calls and faxes
- IP-SNA integration with load-balancing across multiple TN3270E servers
- A convenient, single-price package for IBM 2212 hardware and Access Integration Services software²

¹ Supported IPv6 features are listed in Table 3-1 on page 3-2.

² Adapters and most cables are priced separately.

- Four WAN ports for functionality without purchasing adapters, plus five additional slots³ for Models 4xx. Models 1xx have two additional slots⁴.
- Choice of convenient integrated hard drive or compact flash models
- Power supply and cable support designed for use in organizations worldwide

While offering modularity and scalability to meet tomorrow's networking demands, the IBM 2212 fits within today's budget to provide cost-effective computing across a broad range of remote locations, branch offices, and regional sites.

The IBM 2212 is designed to provide cost-effective network consolidation. Its Virtual Private Network, Thin Server, and TN3270E features can help midsize environments leverage the Internet and intranets to build cost-effective, secure business channels. This chapter explains how to use the IBM 2212 to create secure Internet channels without purchasing expensive leased lines, centrally distribute applications to employee desktops without requiring host access for each transaction, and integrate SNA and IP into a single session to take advantage of cutting-edge Internet technology while preserving your SNA host application investments. The rest of this chapter offers some examples of how you might use the IBM 2212 in your network.

³ Four compact peripheral component interconnect (CPCI) slot for LAN, WAN, ISDN, analog 56K modem, compression/encryption, voice/fax, and T1/J1 and E1 digital modem adapters; and one PCI mezzanine card (PMC) slot for either a Token-Ring or Ethernet LAN adapter. The 4-port WAN adapter will fit in the left PMC slot only.

⁴ One compact peripheral component interconnect (CPCI) slot for LAN, WAN, ISDN, analog 56K modem, compression/encryption, and voice/fax adapters; and one PCI mezzanine card (PMC) slot for either a Token-Ring or Ethernet LAN adapter. The 4-port WAN adapter will fit in the left PMC slot only.

Secure Virtual Private Networks (VPNs)

The IBM 2212 facilitates e-commerce by supporting virtual private networks (VPNs) for extending secure extranets to business partners, customers, and suppliers and allowing employees secure dial-in network access. Designed to protect confidential transactions over the public Internet backbone, VPNs can also provide significant cost savings.

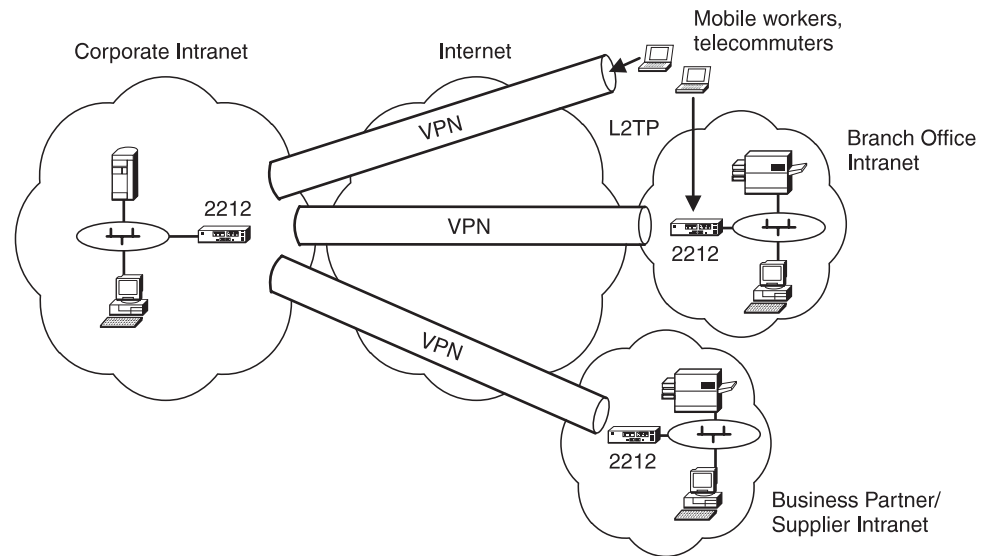

Figure 1-3. Use the 2212 Access Utility to Build Virtual Private Networks

The IBM 2212 provides cryptographic data protection with an emerging, comprehensive Internet security framework, using the IPSec protocol developed by the Internet Engineering Task Force (IETF). IPSec provides complete end-to-end network layer security to protect your data all the way to the target server. IPSec provides three layers of protection:

- Authentication** To verify the identity of the host or end point
- Integrity checking** To ensure that no modifications have been or are made to data packets en route across the network
- Encryption** To conceal data as it travels across the network.

Virtual private networks build "tunnels" that enable secure communication links across TCP/IP networks. With IBM VPN technologies, you can securely integrate the public Internet backbone into your enterprise data communications network to allow suppliers, associates, and clients access to the information they need. Business partners may access VPNs for inventory or product information. Branch offices may access them for corporate data. And remote users may dial in for sales information. Rather than rely on costly leased lines to support these scenarios, VPN technologies enable enterprises to rely on the Internet.

VPNs are part of IBM's overall strategy for ensuring data security. While many VPN solutions today consist only of firewalls, IBM's solutions encompass multi-platform VPN-enabled clients and servers, routers, management functions, ISP ser-

vices, and consulting services (for more information, see “Planning for Virtual Private Networks” on page 7-6).

Internet Key Exchange Function

The Internet Key Exchange (IKE) function ensures that your VPN policy can be conveniently and accurately implemented throughout the extended network with little manual configuration. An IPSec protocol, IKE allows you to automatically set up security associations and manage cryptographic keys. IKE defines a standardized framework to support automated negotiation of security associations, initial generation of all cryptographic keys, and subsequent refresh of these keys. Two methods of identity authentication are supported: digital certificate, which binds a public key to an identity; and pre-shared keys, which are manually configured. A public key infrastructure (PKI) based digital certificate provides a scalable solution for VPN security deployment. Only manual certification registration with a Certificate Authority (CA) is supported.

Accessing Virtual Private Networks

The 2212 Access Utility supports remote access virtual private dial-up networks (VPDNs) via Layer 2 Tunneling Protocol (L2TP), Layer 2 Forwarding (L2F), or Point-to-Point Tunneling Protocol (PPTP).

L2TP, an IETF standards-track protocol, is often used for dial-up, point-to-point protocol (PPP) remote-access traffic. When used with the IPSec protocol, L2TP provides cryptographically strong remote access control in multiprotocol networks. L2F, similar to L2TP and PPTP, carries privately addressed IP, IPX, and AppleTalk dial-up via PPP across the Internet. The IBM 2212 supports both Network Access Server and L2F Gateway, and the two network models: voluntary and compulsory tunneling. Because DIALs clients are supported, L2F does not need to be installed in the client. PPTP uses TCP for exchanging tunnel setup messages and enhanced GRE (Generic Routing Encapsulation) for PPP tunnel transport. The IBM 2212 supports both network models: voluntary tunneling for client initiated and compulsory tunneling for Network Access Servers initiated. Incoming calls, but not outgoing calls are supported. DIALs clients cannot use PPTP. Supported PPTP clients include Microsoft Windows 96 (DUN 1.2 and higher), Windows 98, and Windows NT.

The IBM 2212 supports virtual private networks not only from IP desktops to SNA hosts, but also across all-SNA networks. Data Link Switching transports SNA host and desktop traffic over IP networks. IBM's exclusive Enterprise Extender technology capitalizes on desirable SNA services such as traffic priority and reliable delivery, but over an IP network. By combining IPSec with these technologies, you can safeguard all of your e-business transactions.

The IBM 2212 supports VPN technology over IP version 4 (IPv4) and IP version 6 (IPv6).

Hardware Features

Hardware features increase connectivity and improve performance to deliver VPN solutions:

- The digital modem adapters provide remote access concentration for up to either 48 T1/J1 or 60 E1 simultaneous connections.

- The 4-port analog 56K modem adapters enable a single IBM 2212 Access Utility to terminate up to 16 V.90 dial connections.
- The compression/encryption adapter helps to sustain performance in high-density VPN networks by off-loading these processor-intensive tasks from the main processor.

Voice Integration

The new voice features of the IBM 2212 integrate into existing data network infrastructures. You can reduce the cost of intra-company telephone calls and faxes, without compromising quality.

Three new adapters, based on DSP architecture, offer a variety of analog connectivity options:

2-port Analog FXS Voice/Fax CPCI

For direct connection to a single telephone set or fax machine

2-port Analog FXO Voice/Fax CPCI

For connection to an analog PBX or key system using a public network

2-port Analog E&M Voice/Fax CPCI

For direct connection to an analog PBX or key system

All adapters support Voice over Frame Relay.

Voice over Frame Relay

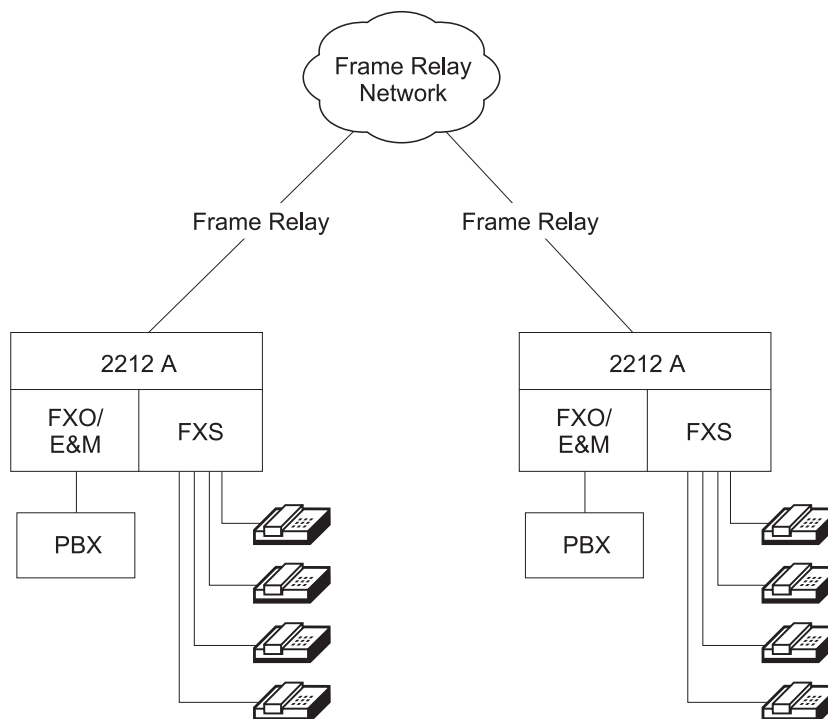

Figure 1-4. Use the 2212 Access Utility to Build Voice Networks

With the voice adapter, voice and fax can be integrated with data traffic on a frame relay network. This frame relay network reduces networking expense by:

- Multiplexing voice/fax and data on a single frame relay data link connection identifier (DLCI)
- Switching voice/fax between frame relay interfaces

- Ensuring voice quality on low speed lines with compression and silence suppression

The analog voice adapter performs voice compression. The IBM 2212 then sends the packets over the frame relay network. At the frame relay network receiving location, the voice traffic is decompressed and sent to the destination station or the private branch exchange (PBX). By using the same DLCI you can transport voice and data over the same frame relay interface. Voice over frame relay uses only permanent virtual circuits (PVC). Fragmentation is used to allow real-time voice and data frames to share the same interface. The user statically configures a maximum of 8 remote node connections to each voice interface. Enhancements to Bandwidth Reservation System classify voice traffic to ensure the quality of voice on low-speed links.

Thin Server for High-Performance Thin Client Computing

In network computing, a master server distributes applications to low-end, low-cost "thin clients" such as the IBM Network Station™. IBM's Thin Server is designed to improve network performance during periods when many Network Stations are accessing the master server or in organizations where Network Stations are separated from the master server by a wide area network (WAN) or multiple LAN hops. With its integrated Thin Server, the IBM 2212 enables high-performance, distributed-load boot, operating system, and configuration caching when and where it's needed.

The Thin Server acts as a proxy for a master server to deliver bring-up code and applications to each Network Station. Each Network Station accesses a nearby Thin Server rather than the master server. Figure 1-5 illustrates a sample placement of the IBM 2212 Thin Server in a network.

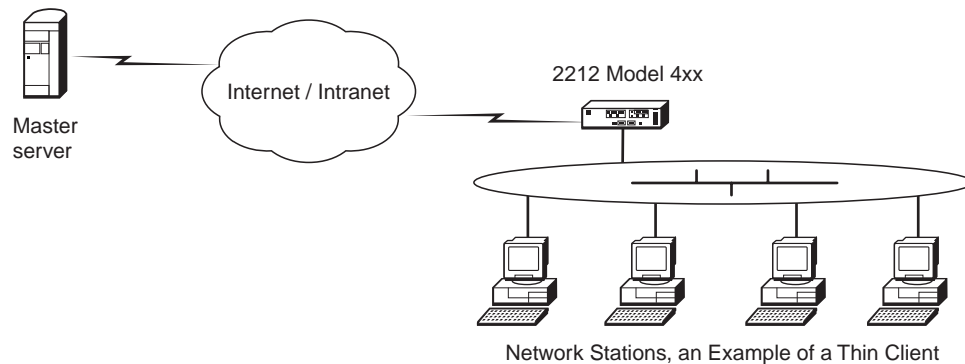

Figure 1-5. Use the 2212 Access Utility as a Thin Server

The Thin Server maintains file concurrency with the master server.

The Thin Server is designed to reduce the WAN costs and host cycles associated with network computing. The IBM 2212 Thin Server enhances performance and central application management by:

- Improving boot-up time for each Network Station
- Reducing the network load of the main site
- Reducing WAN traffic
- Removing the need for a remote server
- Requiring only one server to be at the latest Network Station support level

Web Server Cache

The Web Server Cache feature stores frequently requested web pages for quick retrieval. By storing frequently requested web pages you conserve the server resources used for file serving and communication connections. The IBM 2212 Web Server Cache feature provides high-speed access to web pages while reducing host communications overhead.

Note: You must use a high-performance system card if you want to use the Web Server Cache feature.

The IBM 2212 Web Server Cache:

- Stores the static, unprotected Web pages
- Provides the HTTP clients and servers with access to the cache
- Allows the user to define cache population and invalidation policies
- Uses the Network Dispatcher function to perform workload balancing among servers and provides backup cache capabilities

All IBM 2212 network interfaces that support TCP/IP connectivity, support connectivity between Web Server Cache, HTTP servers, and clients.

IP-SNA Integration with TN3270E Server

TN3270E technology allows IP desktop traffic to access SNA host applications. The IBM 2212 provides a TN3270E logical gateway that integrates SNA and IP to enable IP desktop users to connect to SNA hosts via the Internet, intranets, and extranets. The IBM 2212 supports up to 1000 TN3270E sessions.

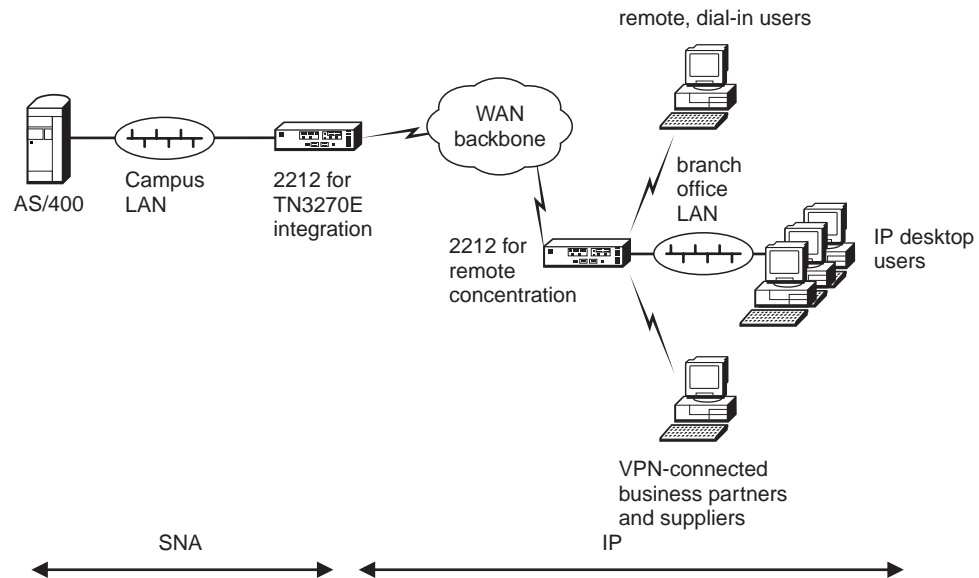

Figure 1-6. Use the 2212 Access Utility as a Midrange TN3270E Server

A Network Dispatcher feature, explained in the following section, provides traffic-load balancing across multiple IP and TN3270E servers. A TN3270E server can coexist in the same IBM 2212 as the Network Dispatcher function.

Load Balancing with Network Dispatcher

The Network Dispatcher function balances traffic load among multiple mail, news, Web, or TN3270E servers as illustrated in Figure 1-7.

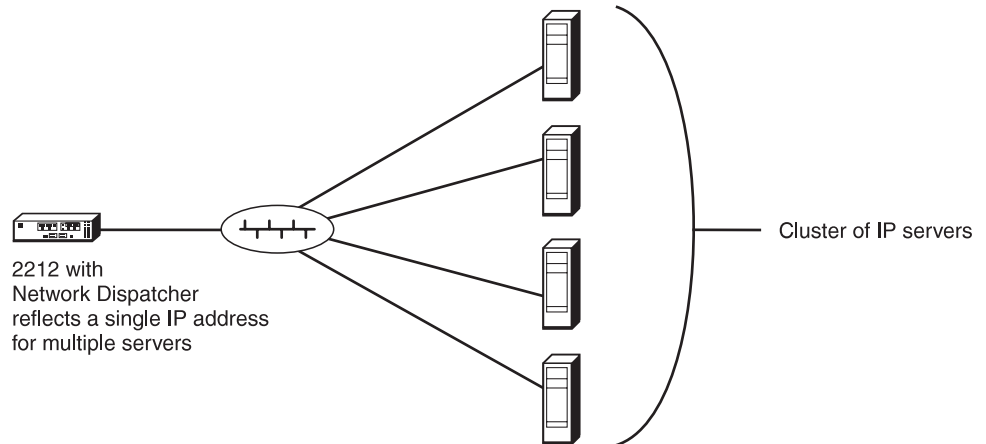

Figure 1-7. Network Dispatcher. Network Dispatcher balances traffic across multiple TCP or UDP servers

When a target server is another IBM 2212 or an IBM 2210 Nways Multiprotocol Router, 2216 Nways Multiaccess Connector, or Network Utility, a set of Advisors query the servers and analyze the results to determine the best distribution of incoming traffic. The Advisors facilitate FTP, HTTP, MVS, SMTP, NNTP, POP3, TN3270E server, and Telnet traffic.

In high-availability scenarios where a second IBM 2212 is used for backup, the two Network Dispatchers synchronize connection and reachability databases. In the event of a failure, the standby IBM 2212 promptly takes over traffic using an IP Takeover function.

General Multiprotocol Routing

Ideal as a general multiprotocol router for midsize networks, the IBM 2212 offers four WAN ports integrated into every model. Models 1xx have one customizable CPCI slot for LAN, WAN, ISDN, analog 56K modem, compression/encryption, and voice/fax adapters; and one PMC slot for a Token-Ring or Ethernet LAN adapters. Models 4xx have four customizable CPCI slots for LAN, WAN, ISDN, analog 56K modem, compression/encryption, voice/fax, and T1/J1 and E1 digital modem adapters; and one PMC slot for a Token-Ring or Ethernet LAN adapters. The 4-port WAN adapter, standard in Models x5x, will fit in the left PMC slot only.

The IBM 2212 provides more connectivity than an entry-level router such as the IBM 2210 Nways Multiprotocol Router. To minimize channel disruption, the IBM 2212 conveniently accesses the host through the corporate data center LAN as illustrated in Figure 1-8.

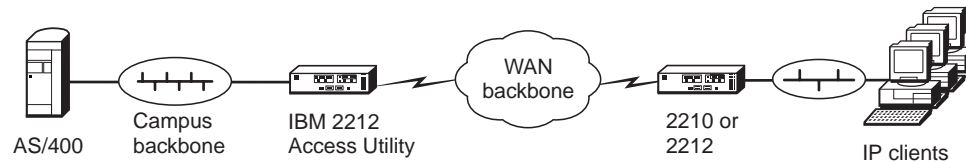

Figure 1-8. Use the 2212 Access Utility for General Multiprotocol Routing

The IBM 2212 is also designed for concentrating the WAN traffic of multiple branch offices or for use as a high-end departmental server. It capitalizes on the common code base, user interface, configuration, and management foundations of the IBM 22xx family of products to provide synergistic cross-platform continuity.

SNA Transport

Capitalizing on IBM's longtime industry leadership in SNA, the IBM 2212 offers High-Performance Routing (HPR) in all-SNA networks for end-to-end flow control, dynamic alternate routing, and priority and bandwidth allocation. The IBM 2212 is also designed as a dependent LU requester (DLUR) and RTP node routing traffic from VSE and other small subarea hosts.

For High-Performance Routing of SNA desktop traffic over IP WAN backbones, the IBM 2212 supports IBM's exclusive Enterprise Extender technology. Related Branch Extender technology, also exclusively from IBM, provides scalability for large SNA networks.

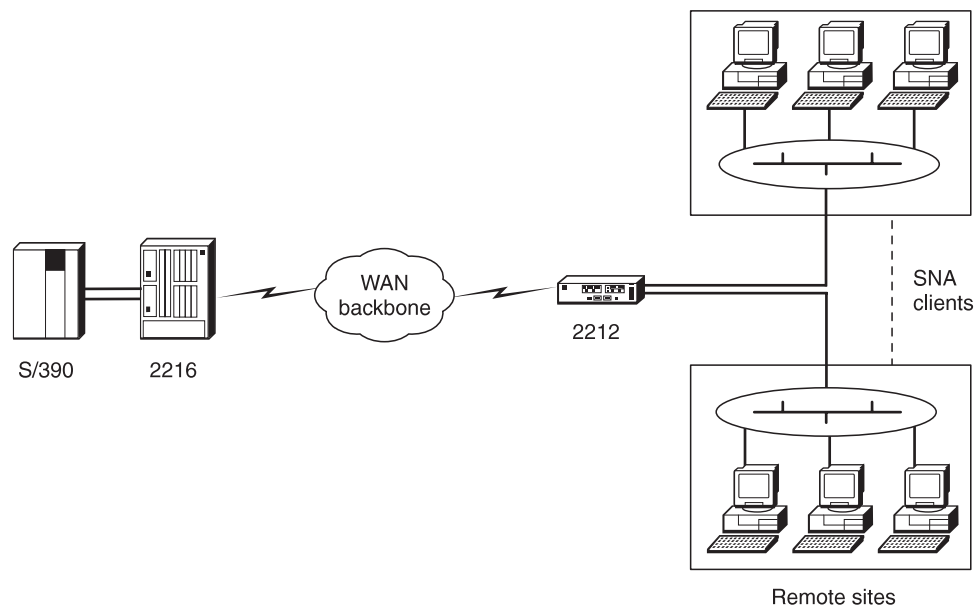

Figure 1-9. Use the 2212 Access Utility for Advanced SNA Transport

The IBM 2212 also supports SLDC and tunneled binary synchronous communication (BSC) to enable mission-critical legacy applications and preserve investments in equipment such as IBM 3x74 controllers, banking controllers, and automated teller machines.

Serviceability

Adapters and the system processor card are accessible from the front panel, allowing replacement without having to remove the IBM 2212 from a rack or remove its covers. The IBM 2212 maintains its configuration and operating history in nonvolatile storage, speeding problem identification and diagnostics. Support information is available at:

<http://www.networking.ibm.com/support/2212>

| You can choose either to service the 2212 Access Utility yourself, or to have IBM
| Service perform on-site service.

Remote Service Capability

You can attach an external modem to the 2212 Access Utility's service port.

IBM designed the Access Utility with a wide array of serviceability features to help you isolate problems quickly and efficiently. The key to these serviceability aids is your providing remote access.

The Access Utility, when combined with a modem that you supply and a telephone line, provides you with enhanced remote access service capabilities. If a modem is available at the time you place a service call, personnel at the IBM Technical Support Center can dial-in to the Access Utility and perform remote service to get your Access Utility up and running with minimal delay.

With this feature, IBM Technical Support can access a broad range of information and perform numerous operations from a remote workstation. Table 1-1 lists examples of the types of information.

Table 1-1. Examples of Information Available Remotely from the Access Utility

Information	Operations
<ul style="list-style-type: none">• Configuration data• Error log data• Trace data• Engineering change (EC) levels• Software levels• Dump data• And other diagnostic information	<ul style="list-style-type: none">• Diagnostics• Problem isolation (hardware/software/configuration)• Start traces• File transfers, such as, Trivial File Transfer Protocol (TFTP)• And other operations

IBM provides these remote service capabilities free of charge, during the warranty period, to enable you to minimize downtime and maximize your service level. Without remote access, IBM's ability to provide installation, configuration, and hardware support may be limited. For example, if IBM needs local data, then IBM must rely on you to obtain and forward that data to IBM by mail, fax, or e-mail. See "Tested Modems" on page 5-7 for a list of modems IBM has tested for use with the 2212 Access Utility's service port.

For additional information about using these remote access characteristics, refer to the *IBM 2212 Access Utility Service and Maintenance Manual*.

Additional Warranty Information

The Access Utility comes with a 1-year hardware warranty. In the United States the warranty is a 1-year advanced mail-in service (available Monday through Friday, excluding holidays). Replacement parts are provided usually within 24 hours, if the request is made before 3 p.m.. Availability of this mail-in service varies in other geographies and should contact your local IBM sales office or authorized business partners for details.

Additional warranty service upgrades are available, which include IBM on-site services. IBM warranty upgrade services can be found at:

<http://www.as.ibm.com/asus/spwarmain.html>

For the upgrade services available in your country, contact IBM through our Web site, or your local IBM sales office.

Chapter 2. IBM 2212 Hardware and Adapters

The IBM 2212 is available in eight models, Models 10F, 15F, 10H, 15H, 40F, 45F, 40H, and 45H.

Models 10F, 10H, 40F, and 40H have:

- A standard system card
- Four integrated WAN ports
- A PCI Mezzanine Card (PMC) slot for a 1-port Ethernet or Token Ring PMC adapter
- Your choice of compact flash (48 MB) or hard drive (over 2 GB).
- Up to 128 MB DRAM

Models 15F, 15H, 45F, and 45H have:

- A high-performance system card
- A 4-port WAN PMC adapter
- A PCI Mezzanine Card (PMC) slot for a 1-port Ethernet or Token Ring PMC adapter
- Your choice of compact flash (48 MB) or hard drive (over 2 GB).
- Up to 512 MB EDO RAM

Each Model 1xx has one compact peripheral component interconnect (CPCI) slot for network adapters.

Each Model 4xx has four CPCI slots for network adapters.

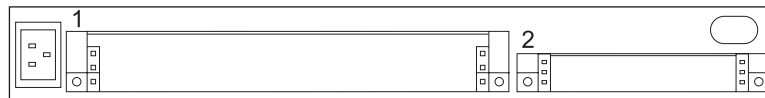

Figure 2-1. IBM 2212, Models 1xx

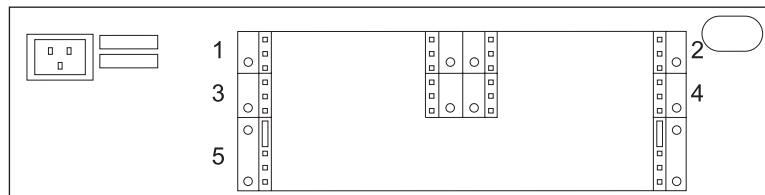

Figure 2-2. IBM 2212, Models 4xx

Table 2-1. Comparing Models of the IBM 2212

Feature	Model 10F	Model 15F	Model 10H	Model 15H	Model 40F	Model 45F	Model 40H	Model 45H
Integrated standard WAN ports (See Note 1)	4	4	4	4	4	4	4	4
CPCI Adapter Slots	1	1	1	1	4	4	4	4
PCI Mezzanine Card (PMC) Adapter Slots (See Note 4)	1	2	1	2	1	2	1	2
Storage Media	Compact flash	Compact flash	Hard drive	Hard drive	Compact flash	Compact flash	Hard drive	Hard drive
Size of Storage	48 MB	48 MB	over 2 GB	over 2 GB	48 MB	48 MB	over 2 GB	over 2 GB
Base DRAM (See Note 2)	64 MB, upgradable to 128 M	64 MB, upgradable to 512 MB	64 MB, upgradable to 128 M	64 MB, upgradable to 512 MB	64 MB, upgradable to 128 M	64 MB, upgradable to 512 MB	64 MB, upgradable to 128 M	64 MB, upgradable to 512 MB
Preloaded Code	Standard	High-Performance	Enterprise	High-Performance Enterprise	Standard	High-Performance	Enterprise	High-Performance Enterprise (See Note 3)
EIA-232 Service Port	1	2	1	2	1	2	1	2

Notes:

1. The integrated standard WAN ports support the same media attachments and features as the 4-port CPCI WAN adapter on page 2-6.
2. DRAM provides the working memory for the router program and router network tables.
3. Standard, Enterprise, High-Performance, High-Performance Enterprise code load contents are listed in Table 3-1 on page 3-2.
4. On Models x5x, one of the two PMC adapter slots is used for the 4-port WAN PMC adapter.

Storage

Multiple compressed versions of the Access Integration Services software and multiple configuration files are stored in your IBM 2212. The storage media is either compact flash or a hard drive.

Hard Drive

Each IBM 2212 with hard drive storage contains two copies of its operational software and up to four configurations for each operational software load (for a total of eight configuration files) in each of two data banks. You can also use the hard drive models to store logs, dumps, and system support data. The hard drive contains at least 2 GB of nonvolatile storage.

Compact Flash

Like the hard drive storage model, the compact flash models (1xF and 4xF) include enough nonvolatile storage (48 MB) to contain two copies of the operational software and up to four configurations for each operational software load (for a total of eight configuration files) in each of two data banks. However, with the compact flash models you must use a LAN-attached network server if you wish to store logs and memory dump files. Because logs and dump files would be needed in the event of a network problem, it is strongly recommended that you use a network server with the IBM 2212 compact flash models.

Network Server

You can use a network server as more than just a storage device for the compact flash models of the IBM 2212. You can use a network server with all models:

- To store configuration files generated by the configuration tool and to transfer them to the router if the configuration tool's communication options feature cannot be used
- To provide temporary storage for dump and log files that are transferred out of the IBM 2212's hard drive
- To load new code

Note: If you choose to use a network server with the IBM 2212, be sure the meet the requirements listed on "Network Server Requirements" on page 5-7.

Determining Whether to Order a Hard Drive or Compact Flash Model

When determining which model to order, you should keep in mind that:

- To have the Enterprise code preloaded, you will need to order a hard drive model.
- A hard drive model allows traces, dumps, and other problem determination data to be stored without using an external file server. It is required if you plan to run the APPN topology safe-store function on your IBM 2212. It is recommended for IBM 2212s acting as SNA/APPN nodes.
- A compact flash model requires a TFTP network server with LAN interface access to the IBM 2212. The server provides a place for the IBM 2212 to dump network information and draw on for loading new code images. The server must have sufficient disk space to accommodate dumps, log files, and config-

uration files. For more information about determining storage requirements for the server, see “Network Server Requirements” on page 5-7.

- The IBM 2212 Thin Server function can operate with either a compact flash or a hard drive; however, a hard drive is recommended because network station files are saved directly to the hard drive and updated only when they have changed. Each time a IBM 2212 with compact flash and Thin Server network station support is reloaded or restarted, the memory cache is cleared and all the network station files must be retrieved from the master server.

Options

The IBM 2212 ships with unpopulated adapter slots. You can customize it to meet your needs with the PMC and CPCI adapters listed in this section.

With one CPCI adapter slot each, Models 10F, 15F, 10H, and 15H are suited for well-defined connectivity opportunities requiring only one CPCI adapter.

With four CPCI adapter slots each, Models 40F, 45F, 40H, and 45H offer scalable support for your network as it expands.

You can order the following adapters for the IBM 2212:

Table 2-2. IBM 2212 Adapters, Feature Codes, and Part Numbers

Adapter	Feature Code	Part Number	Page
<i>PMC adapter options</i>			
1-Port Token-Ring PMC	3101	85H4721	2-6
1-Port 10/100 Ethernet PMC	3102	85H4722	2-6
<i>CPCI adapter options</i>			
4-Port WAN CPCI	3103	85H8836	2-6
2-Port ISDN BRI-U CPCI	3104	85H4725	2-7
2-Port ISDN BRI-S/T CPCI	3105	85H4726	2-7
1-Port ISDN PRI T1/J1 CPCI	3106	85H4727	2-7
1-Port ISDN PRI E1 CPCI	3107	85H4728	2-8
2-Port ISDN PRI T1/J1 CPCI	3108	85H4680	2-8
2-Port ISDN PRI E1 CPCI	3109	85H4682	2-8
2-Port Token-Ring CPCI	3110	85H4717	2-8
2-Port 10/100 Ethernet CPCI	3111	85H4735	2-9
2-Port Analog FXS Voice/Fax CPCI	3210	85H8828	2-11
2-Port Analog FXO Voice/Fax CPCI	3211	02L2398	2-11
2-Port Analog E&M Voice/Fax CPCI	3212	02L2400	2-11
4-Port Analog 56K Modem CPCI	3213	85H8831	2-11
Compression/Encryption CPCI Adapter	3215	85H4732	2-11
<i>CPCI adapter options available for Models 4xx only:</i>			
T1/J1 24-channel Digital Modem Adapter	3201	85H8812	2-9
T1/J1 12-channel Digital Modem Adapter	3202	35H2262	2-9
E1 30-channel Digital Modem Adapter	3204	25L5606	2-10
E1 12-channel Digital Modem Adapter	3205	35L2263	2-10

If you have a standard system card you can also order the following additional options for the IBM 2212:

- 32-MB DRAM SIMM (FC 3132, PN 85H4408)
- 64-MB DRAM SIMM (FC 3133, PN 85H4409)
- Hard drive (FC 3130, PN 85H4715) to make a compact flash model into a hard drive model

If you have a high-performance system card you can also order the following additional options for the IBM 2212:

- 64-MB EDO DRAM DIMM (FC 3233, PN 44L2537)
- 128-MB EDO DRAM DIMM (FC 3234, PN 44L2539)
- 256-MB EDO DRAM DIMM (FC 3235, PN 44L2541)
- Hard drive (FC 3130, PN 85H4715) to make a compact flash model into a hard drive model

Note: The IBM 2212 allows a hard drive or compact flash option; not both.

1-Port Token-Ring PMC Adapter (FC 3101, PN 85H4721)

Provides for one attachment to a 4- or 16-Mbps Token-Ring LAN wired with 100-ohm twisted-pair cable using RJ-45 connectors. For attachment to 150-ohm wiring systems, an impedance converter such as IBM PN 73G8315 must be used. Cable FC 2391 (PN 41H9082) is available for this adapter.

This adapter plugs into the PMC adapter slot on the system card.

Note: Total cable length to the attaching device is limited to 100 m (328 ft) and is for indoor use, only.

1-Port 10/100-Mbps Ethernet PMC Adapter (FC 3102, PN 85H4722)

Provides one port for 10/100-Mbps Ethernet connections using an RJ-45 connector. This attachment provides:

- 2-KB entry hardware Transparent Bridging
- IEEE 802.3 10-Mbps Ethernet
- IEEE 802.3u 100-Mbps Ethernet

It plugs into the PMC adapter slot on the system card. Cable FC 2391 (PN 41H9082) is available for this adapter.

4-Port WAN CPCI Adapter (FC 3103, PN 85H8836)

Each port of the 4-port WAN CPCI adapter, 4-port WAN PMC adapter, and integrated WAN ports supports any of the following interfaces and speeds and complies with the respective interface standard:

EIA 232D/V.24 2400 bps to 115.2 Kbps

V.35 9600 bps to 6.312 Mbps is supported with external clocking¹ and 9600 bps to 2.048 Mbps is supported with internal clocking.

V.36 9600 bps to 6.312 Mbps is supported with external clocking¹ and 9600 bps to 2.048 Mbps is supported with internal clocking.

X.21 2400 bps to 6.312 Mbps is supported with external clocking¹ and 2400 bps to 2.048 Mbps is supported with internal clocking.

The optional CPCI adapter, the integrated WAN ports on the IBM 2212 standard system card, and the 4-port WAN PMC adapter for the high-performance system card support the 8 cables listed under "WAN cables" in "Cables" on page 2-12.

The optional adapter plugs into any 3U CPCI adapter slot. (For more information about CPCI dimensions, see "CPCI Adapter Specifications" on page 5-3).

¹ When speeds above 2.048 Mbps are used, only port number 1 on an adapter can be clocked at this rate. Ports 2, 3, and 4 must be running at 64 Kbps or less.

2-Port ISDN BRI-U CPCI Adapter (FC 3104, PN 85H4725)

Provides a 2-wire U interface per port for North America. Uses an RJ-45 connector. Support for cable FC 2391 (PN 41H9082).

This adapter plugs into any 3U CPCI adapter slot.

2-Port ISDN BRI-S/T CPCI Adapter (FC 3105, PN 85H4726)

Provides a 4-wire S/T interface per port. Uses an RJ-45 connector.

This adapter requires cable FC 2391 (PN 41H9082), except in Australia, where it requires cable FC 2318 (PN 86H0774).

Note: Requires an external network termination (NT-1) for connections in North America.

This adapter plugs into any 3U CPCI adapter slot.

1-Port ISDN PRI (T1/J1) CPCI Adapter (FC 3106, PN 85H4727)

Provides one attachment to an ISDN Primary Rate service at T1/J1 speed.

Note: This can also be used for channelized or fractional T1/J1 support.

This attachment provides:

- Support for T1/J1 line speed of 1.544 Mbps.
- Twenty-three 64-Kbps B-channels for data and one 64-Kbps D-channel for signaling, or twenty-four 64-Kbps time slots (24 DS0s) for channelized service.
- Selectable framing to D4 (SF) format.
- Detection and generation of yellow and blue alarms.
- Facility Data Link (FDL) support.
- Generation of DSX-1 and CSU line build outs.
- Generation and detection of CSU loop codes.
- Line error counters for BPV, CV, CRC6, and framing-bit errors.
- Monitoring and enforcing of ANSI ones density requirement.
- B8ZI and AMI line coding.
- RJ-45 female connector.
- Support for cables FC 2391 (PN 41H9082) and for Japan FC 2323 (PN 30L6523).
- Two separate loopbacks for testing: payload and line. The diagnostics program provides a local loopback, as well.

This adapter plugs into any 3U CPCI adapter slot.

1-Port ISDN PRI (E1) CPCI Adapter (FC 3107, PN 85H4728)

Note: This can also be used for channelized E1.

Provides one attachment to an ISDN Primary Rate service at E1 speed. This attachment provides:

- Support for E1 line speed of 2.048 Mbps.
- Thirty 64-Kbps B-channels for data and one 64-Kbps D-channel for signaling or thirty-one 64-Kbps time slots (31 DSOs) for channelized service.
- Selectable framing to FAS and CRC4 formats.
- Detection and generation of remote and AIS alarms.
- Generation of line build outs for a 120-ohm line.
- Two separate loopbacks for testing: payload and line. The diagnostics program provides a local loopback, as well.
- Line error counters for bipolar and code violations, CRC4 code word errors, FAS errors, and E-bits.
- B8ZI, AMI, and HDB3 line encoding.
- RJ-45 female connector.
- Support for cable FC 2324 (PN 30L6524) and in Australia for FC 2325 (PN 30L6529).

This adapter plugs into any 3U CPCI adapter slot.

2-Port ISDN PRI T1/J1 CPCI Adapter (FC 3108, PN 85H4680)

Provides two ports to an ISDN Primary Rate or channelized service at T1 speed. This attachment provides the same functions as “1-Port ISDN PRI (T1/J1) CPCI Adapter (FC 3106, PN 85H4727)” on page 2-7. It supports cables FC 2391 (PN 41H9082) and, for Japan, FC 2323 (PN 30L6523).

This adapter plugs into any 3U CPCI adapter slot.

2-Port ISDN PRI E1 CPCI Adapter (FC 3109, PN 85H4682)

Provides two ports to an ISDN Primary Rate or channelized service at E1 speed. This attachment provides the same functions as “1-Port ISDN PRI (E1) CPCI Adapter (FC 3107, PN 85H4728)” on page 2-8. It supports cables FC 2324 (PN 30L6524) and, for Australia, FC 2325 (PN 30L6529).

This adapter plugs into any 3U CPCI adapter slot.

2-Port Token-Ring CPCI Adapter (FC 3110, PN 85H4717)

Provides for two attachments to 4- or 16- Mbps Token-Ring LANs wired with 100-ohm unshielded twisted-pair cable using RJ-45 connectors. For attachment to 150-ohm Token-Ring wiring systems, an impedance converter such as IBM PN 73G8315 must be used.

This adapter plugs into any 3U CPCI adapter slot. Cable FC 2391 (PN 41H9082) is available for this adapter.

Note: Total cable length to the attaching device is limited to 100 m and is for indoor use, only.

2-Port 10/100-Mbps CPCI Ethernet Adapter (FC 3111, PN 85H4735)

Provides two ports for either 10-Mbps or 100-Mbps Ethernet connections using RJ-45 connectors. These attachments provide:

- 2-KB entry hardware Transparent Bridging
- IEEE 802.3 10-Mbps Ethernet
- IEEE 802.3u 100-Mbps Ethernet

This adapter plugs into any 3U CPCI adapter slot. Cable FC 2391 (PN 41H9082) is available for this adapter.

T1/J1 24 Channel Digital Modem Adapter (FC 3201, PN 85H8812)

This adapter provides:

- Support for T1/J1 line speed of 1.544 Mbps
- Twenty-three 64-Kbps B-channels for data and one 64-Kbps D-channel for signaling, or twenty-four 64-Kbps time slots (24 DS0s) for channelized service
- Selectable framing to D4 format for channelized and CAS support
- Selectable framing to ESF for ISDN channelized, CAS, and switch support
- Detection and generation of yellow and blue alarms
- Facility Data Link (FDL) support
- Generation of DSX-1 and CSU line build outs
- Generation and detection of CSU loop codes
- Line error counters for BPV, CV, CRC6, and framing-bit errors
- Monitoring and enforcing of ANSI ones density requirement
- B8ZI and AMI line coding
- RJ-45 female connector
- Support for cables FC 2326 (PN 30L6571) and for Japan FC 2328 (PN 30L6573).

Note: The cable you receive with your T1/J1 Digital Modem Adapter is required for Electromagnetic Compatibility (EMC) compliance.

This adapter plugs into any 6U CPCI adapter slot.

T1/J1 12-Channel Digital Modem Adapter (FC 3202, PN 35H2262)

This adapter provides:

- Support for T1/J1 line speed of 1.544 Mbps
- Twenty-three 64-Kbps B-channels for data and one 64-Kbps D-channel for signaling, or twenty-four 64-Kbps time slots (24 DS0s) for channelized service
- Selectable framing to D4 format for channelized and CAS support
- Selectable framing to ESF for ISDN channelized, CAS, and switch support
- Detection and generation of yellow and blue alarms

- Facility Data Link (FDL) support
- Generation of DSX-1 and CSU line build outs
- Generation and detection of CSU loop codes
- Line error counters for BPV, CV, CRC6, and framing-bit errors
- Monitoring and enforcing of ANSI ones density requirement
- B8ZI and AMI line coding
- RJ-45 female connector
- Support for cables FC 2326 (PN 30L6571) and for Japan FC 2328 (PN 30L6573).

Note: The cable you receive with your T1/J1 Digital Modem Adapter is required for Electromagnetic Compatibility (EMC) compliance.

This adapter plugs into any 6U CPCI adapter slot.

E1 30-Channel Digital Modem Adapter (FC 3204, PN 25L5606)

This adapter provides:

- Support for E1 line speed of 2.048 Mbps.
- Thirty 64-Kbps B-channels for data and one 64-Kbps D-channel for signaling or thirty-one 64-Kbps time slots (31 DS0s) for channelized service.
- Selectable framing to FAS and CRC4 formats.
- Detection and generation of remote and AIS alarms.
- Generation of line build outs for a 120-ohm line.
- Two separate loopbacks for testing: payload and line. The diagnostics program provides a local loopback, as well.
- Line error counters for bipolar and code violations, CRC4 code word errors, FAS errors, and E-bits.
- B8ZI, AMI, and HDB3 line encoding.
- RJ-45 female connector.
- Support for cable FC 2327 (PN 30L6572).

Note: The cable you receive with your E1 Digital Modem Adapter is required for Electromagnetic Compatibility (EMC) compliance.

This adapter plugs into any 6U CPCI adapter slot.

E1 12-Channel Digital Modem Adapter (FC 3205, PN 35L2263)

This adapter provides:

- Support for E1 line speed of 2.048 Mbps.
- Thirty 64-Kbps B-channels for data and one 64-Kbps D-channel for signaling or thirty-one 64-Kbps time slots (31 DS0s) for channelized service.
- Selectable framing to FAS and CRC4 formats.
- Detection and generation of remote and AIS alarms.
- Generation of line build outs for a 120-ohm line.

- Two separate loopbacks for testing: payload and line. The diagnostics program provides a local loopback, as well.
- Line error counters for bipolar and code violations, CRC4 code word errors, FAS errors, and E-bits.
- B8ZI, AMI, and HDB3 line encoding.
- RJ-45 female connector.
- Support for cable FC 2327 (PN 30L6572).

Note: The cable you receive with your E1 Digital Modem Adapter is required for Electromagnetic Compatibility (EMC) compliance.

This adapter plugs into any 6U CPCI adapter slot.

2-Port Analog FXS Voice/Fax CPCI (FC 3210, PN 85H8828)

Provides two ports that allow attachment of analog telephone handset or analog fax machine to the IBM 2212.

This adapter plugs into any 3U CPCI adapter slot.

2-Port Analog FXO Voice/Fax CPCI (FC 3211, PN 02L2398)

Provides two analog voice ports that allow attachment to analog central office trunks.

This adapter plugs into any 3U CPCI adapter slot.

2-Port Analog E&M Voice/Fax CPCI (FC 3212, PN 02L2400)

Provides two analog voice ports that provide analog PBX emulation for attachment to private networks.

This adapter plugs into any 3U CPCI adapter slot.

4-Port Analog 56K Modem CPCI (FC 3213, PN 85H8830)

This adapter allows up to four analog phone line connections. The modems support the V.34 standard up to 33.6 Kbps as well as K56Flex technology and the new V.90 ITU standard for speeds up to 56 Kbps. Transmit rates are limited to a maximum of 33.6 Kbps. Only asynchronous protocols, that is, dial-up PPP, are supported.

The external interface for each modem is a RJ-11 connector.

This adapter plugs into any 3U CPCI adapter slot.

Compression/Encryption CPCI Adapter (FC 3215, PN 85H4732)

Provides a coprocessor with dedicated memory. When the software begins to perform compression and encryption functions it uses the coprocessor's memory to prevent a decline in performance. After you install and enable this compression/encryption adapter in the IBM 2212 the AIS software uses the coprocessor for compression and encryption packet processing. This adapter provides:

- CDMF, DES, Triple-DES, RC4 encryption support

Note: Encryption support is controlled by the AIS software and is subject to export control. Before the compression/encryption adapter can be used for data encryption you must download the version of the AIS software with data encryption support. You can obtain this software at:

<http://www.networking.ibm.com/support/downloads/2212>

- LZS, and MPPC compression support
- 127/63 simultaneous full-duplex LZS/MPPC compression sessions

This adapter plugs into any 3U CPCI adapter slot.

Cables

Note: Most adapters do not ship with cabling. Remember to order cables separately if your adapter requires them.

WAN Cables

The following WAN cables are supported on the 4-port WAN CPCI Adapter option (FC 3103, PN 85H8836) and on the integrated 4-port WAN adapter (shipping as part of all models of the IBM 2212).

In some instances, two cables are available for one media type. In those cases, one cable is a modem-attach cable for attaching the IBM 2212 to a modem/DCE and the other is a direct-attach cable for attaching the IBM 2212 directly to another device without a modem, CSU/DSU, or modem eliminator.

For a modem-attach cable, the IBM 2212 acts as the DTE for clocking on the serial line. For a direct-attach cable, the IBM 2212 acts as the DCE for clocking on the serial line. Direct attachment provides a software-enabled modem eliminator function including clocking for the attached device.

Modem-attach cables have male connectors. Direct-attach cables have female connectors. The connection to each port is a 10-foot cable with a 26-pin miniature connector.

- EIA-232D/V.24 Serial Interface (or modem-attach) Cable (FC 2321, PN 55H7756)

This is a 3-m (9-ft 10-in.) extension cable with a 25-pin D-shell male connector for attachment to a modem.

- EIA-232D/V.24 Direct Attach Cable (FC 2322, PN 60G3901)

This is a 3-m (9-ft 10-in.) cable with a 25-pin D-shell female connector for direct-device attachment.

- V.35 Serial Interface (or modem-attach) Cable (FC 2351, PN 60G3902)

This is a 3-m (9-ft 10-in.) extension cable with a 34-pin male block connector for attachment to a modem.

- V.35 Direct Attach Cable (FC 2352, PN 60G3903)

This is a 2-m (6-ft 7-in.) cable with a 34-pin female block connector for direct-device attachment.

- V.36 Serial Interface (or modem-attach) Cable (FC 2361, PN 60G3904)

This is a 3-m (9-ft 10-in.) extension cable with a 37-pin male D-shell connector for attachment to a modem.

- X.21 Serial Interface (or modem-attach) Cable (FC 2211, PN 60G3906)

This is a 3-m (9-ft 10-in.) extension cable with a 15-pin D-shell male connector for attachment to a modem.

- X.21 Direct Attach Cable (FC 2212, PN 10H5591)

This is a 3-m (9-ft 10-in.) cable with a 15-pin D-shell female connector for direct-device attachment.

- Attachment Cable for V.35 DCE (FC 2703, PN 1749352) - for France

This is a 30-cm (1-ft) cable that adapts the standard V.35 34-pin male block connector to the connector required for attachment to V.35 modems in France.

Digital Modem Cables

- E1 Digital Modem cable (FC 2327, PN 30L6572)

This cable is a 15-m (50-ft), crossover, shielded twisted pair, Category 5 cable. One end of the cable is terminated with flying leads, the other with an RJ-45 plug wired for RJ-48C, suitable for attachment to the E1 Digital Modem adapter.

- T1 Digital Modem cable (FC 2326, PN 30L6571)

This cable is a 15-m (50-ft), shielded twisted pair, Category 5 cable. Both ends of the cable are terminated with an RJ-45 plug wired for RJ-48C, for attachment to the T1 Digital Modem adapter.

- J1 Digital Modem cable (FC 2328, PN 30L6573)

This cable is a 15-m (50-ft), shielded twisted pair Category 5 cable. The cable terminates with a RJ-45 plug wired for RJ-48C, suitable for attachment to the T1/J1 Digital Modem adapter. This cable is suitable for use in Japan.

Multipurpose Cables

- Multipurpose RJ-45 Adapter Cable (FC 2391, PN 41H9082)

This is a 7.6-m (25-ft) Category 5 cable with an RJ-45 connector for attachment to Token-Ring hubs or switches, Ethernet 10BASE-T hubs or switches, or ISDN BRI-U, ISDN BRI-S/T, and ISDN T1 PRI switches.

ISDN Cables

- ISDN PRI E1 cable (FC 2324, PN 30L6524)

This cable is a 15-m (49-ft), crossover, unshielded twisted pair, Category 3 cable. One end of the cable is terminated with flying leads, the other with an RJ-45 plug wired for RJ-48C, suitable for attachment to the ISDN PRI E1 adapter.

- ISDN PRI E1 cable for Australia (FC 2325, PN 30L6529)

This cable is a 4-m (13-ft), unshielded twisted pair, Category 3 cable. One end of the cable is terminated with flying leads, the other with an RJ-45 plug wired for RJ-48C, for attachment to the ISDN PRI E1 adapter. This cable is suitable for use in Australia.

- ISDN PRI J1 cable (FC 2323, PN 30L6523)

This cable is a 15-m (49-ft), unshielded twisted pair Category 3 cable. The cable terminates with a keyed RJ-45 plug wired for ISO-10173, suitable for attachment to the ISDN PRI T1/J1 adapter. This cable is suitable for use in Japan.

- ISDN BRI cable for Australia (FC 2318, PN 86H0774)
This cable is a 4-m (13-ft.), RJ-45 Category-5 cable.

Options that IBM Does Not Offer

Token-Ring STP network adapter cables are not provided as options for the IBM 2212. You must obtain them if they are required.

IBM does not provide analog telephone handsets for use with the 2-Port Analog FXS Voice/Fax CPCI adapter.

No cables are required for the compression/encryption adapter. There are no I/O ports on the adapter.

IBM does not provide cables for use with the 4-Port Analog 56K Modem adapter. The minimum cable requirement is standard phoneline cable with at least one RJ-11 connector plug that plugs into any one of the four RJ-11 connector receptacles of the 4-Port Analog 56K Modem adapter. Consult your local phone company if you are unsure of the correct cable to use.

Chapter 3. IBM 2212 Network and Protocol Support

This chapter includes the following sections:

- “Networks Supported”
- “Protocols and Features Supported” on page 3-2
- “Framing Support” on page 3-5.

Networks Supported

The LANs supported by the IBM 2212 are:

- Token-ring (IEEE 802.5) with RJ-45 connection
- Ethernet IEEE 802.3 with 10BASE-T (RJ-45) connection
- 100-Mbps Ethernet (IEEE 802.3u with RJ-45 connection)

The physical interfaces supported by the IBM 2212's 4-port WAN CPCI adapter and integrated WAN ports on the system processor card are:

- EIA-232D/V.24
- V.35
- V.36
- X.21

The digital modem adapter (E1 and T1/J1) supports:

- ITU data modes:
 - V.90
 - K56Flex
 - V.34
 - V.FC
 - V32bis
 - V.32
 - V.22bis
 - V22A/B
 - V.23
 - V.21
- Bell 212A and 103

The 4-port analog 56K modem adapter supports:

- K56Flex
- ITU V.90
- ITU V.34

The other interfaces supported by the IBM 2212 are:

- ISDN Primary (E1 and T1/J1)
- ISDN Basic Rate Interface-S/T (BRI-S/T)
- ISDN BRI-U
- Voice Adapter:
 - FXS
 - FXO
 - E&M: Types I, II, and V

Protocols and Features Supported

Table 3-1 lists the protocols and features that the IBM 2212 supports.

Table 3-1 (Page 1 of 2). IBM 2212 Protocol and Feature Support

Protocol			IBM 2212 Models
<i>IP</i>	<i>IPv4</i>	<i>IPv6</i>	
TCP	yes	yes	yes
UDP	yes	yes	yes
ICMP	yes	yes	yes
Neighbor Discovery Protocol (NDP)		yes	yes
IPv6 over IPv4 with manually configured tunneling	yes	yes	yes
IGMP/Multicast Listener Discovery Protocol (MLD)	yes	yes	yes
Static routes	yes	yes	yes
RIP	yes	yes	yes
Open Shortest Path First (OSPF) V2	yes		yes
Multicast extensions to OSPF (MOSPF)	yes		yes
Distance Vector Multicast Routing Protocol (DVMRP)	yes		yes
Border Gateway Patrol (BGP-4)	yes		yes
Protocol Independent Multicast Dense Mode		yes	yes
VRRP	yes		yes
IPSec	yes	yes	yes
Network Address Translation (NAT)	yes		yes
RSVP	yes		yes
IP Access Control	yes	yes	yes
BOOTP/DHCP Forwarding	yes	yes	yes
Ping	yes	yes	yes
Traceroute	yes	yes	yes
Telnet	yes	yes	yes
<i>SNA, including IP integration</i>			
APPN ⁵			yes
TN3270E Server ⁵			yes
Data Link Switching (DLSw) ^{1, 5}			yes
(Boundary Access Node) BAN ⁵			yes
Branch Extender ⁵			yes
Dependent LU Requester (DLUR) ⁵			yes
Enterprise Extender ⁵			yes
Extended Border Node ⁵			yes
High-Performance Routing (HPR) ⁵			yes
Network node (NN) ⁵			yes
<i>Bridging</i>			
Source-route bridging (SRB)			yes
Source-route transparent (SRT) bridging			yes
Source Route to transparent translational bridging (SR/TB)			yes
Transparent bridging (TB)			yes
IP bridging tunnels			yes
<i>Network Management Protocols</i>			
Simple Network Management Protocol (SNMP)			yes
LAN Network Manager (LNM)			yes

Table 3-1 (Page 2 of 2). IBM 2212 Protocol and Feature Support

Protocol			IBM 2212 Models
<i>Other Protocols</i>			
AppleTalk2			yes
Address Resolution Protocol (ARP)			yes
Inverse Address Resolution Protocol (InARP)			yes
Banyan VINES			yes
DECnet IV			yes
DECnet V / OSI			yes
IPX			yes
NetBIOS			yes
IBM 2212 Features			
Thin Server ^{5, 6}			yes
Network Dispatcher			yes
Dial-in/Dial-out access for LANs (DIALs)			yes
Bandwidth reservation and Priority queuing ³			yes
MAC filtering			yes
WAN restoral			yes
WAN reroute ²			yes
Compression and Encryption ⁸			yes
IP Security			yes
Layer 2 Tunneling (L2TP, PPTP, and L2F)			yes
Authentication, Authorization, and Accounting Security (AAA) ⁴			yes
Web Server Cache ⁷			yes
DHCP server			yes

Notes:

1. Including NetBIOS support (RFCs 2166, 1795 and 1434)
2. For recovery from FR, PPP, or X.25 link failures
3. Over FR and PPP
4. For PPP and for login users
5. **Available in the Enterprise or High-Performance Enterprise code loads.**
6. For AS/400 RFS and NFS servers
7. You must use a high-performance system card if you want the web server cache feature. The web server cache feature is not available in the standard, high-performance, enterprise, or high-performance enterprise code loads. The web server cache feature is available in a separate code load.
8. For FR and PPP. Encryption, but not compression, also supports IPSec.

Protocol Support, by Interface

Table 3-2. IBM 2212 Protocol Support, by Interface

Framing Methods	WANs						LANs	
	PPP	FR	X.25	SDLC	V.25 bis, V.34, and ISDN		Ethernet	Token Ring
					Dial on Demand	Dial Backup		
Protocols								
IPv4	yes	yes	yes	no	yes	yes	yes	yes
IPv6	yes	no	no	no	yes	yes	yes	yes
SNA	yes	yes	yes	yes	yes	yes	yes	yes
SRB	yes	yes	yes ³	no	yes	yes	no	yes
TB	yes	yes	yes ³	no	yes	yes	yes	yes
SRT	yes	yes	yes ³	no	yes	yes	yes	yes
SR/TB	yes	yes	yes ³	no	yes	yes	yes	yes
AppleTalk	yes	yes	yes ¹	no	yes	yes	yes	yes
Banyan VINES	yes	yes	yes	no	yes	yes	yes	yes
DECnet IV	yes	yes	yes ²	no	yes	yes	yes	yes
DECnet V/OSI	yes	yes	no ¹	no	yes	yes	yes	yes
IPX	yes	yes	yes	no	yes	yes	yes	yes
NetBIOS	yes	yes	yes	no	yes	yes	yes	yes

Notes:

1. Routing of this protocol is not supported on X.25 interfaces; however, if this protocol is being bridged, the IP tunnel function can be used to send bridge packets over an X.25 interface.
2. DECnet IV is supported on X.25 only in the IBM modes of operation, not in the DEC compatibility modes.
3. Bridging is not supported natively on X.25; however, the IP bridge tunnel function can be used to send bridge packets over X.25 interfaces.

Framing Support

Table 3-3. IBM 2212 Framing Method Support

Framing Method	IBM 2212 Models
Token-Ring	yes
10/100 Mbps Ethernet	yes
PPP	yes
Frame Relay	yes
X.25	yes
V.25bis	yes
V.34	yes
Binary Synchronous Communication (BSC) ²	yes
SDLC (both primary and secondary) ¹	yes
ISDN (both basic rate [BRI] and primary rate [PRI])	yes

Notes:

1. SDLC SNA traffic can be handled either natively using an SDLC interface and DLSw or APPN, or tunneled over IPv4 using the SDLC Relay function.
2. Bisync framing is handled by configuring a Bisync interface on a WAN adapter and using the Binary Synchronous (BSC) Relay function to tunnel the Bisync packets over IPv4.

Chapter 4. Access Integration Services Software

The 2212 Access Utility is built from the same solid code base that supports the IBM 2210 Nways Multiprotocol Router and IBM 2216 Nways Multiaccess Connector. The Access Integration Services software, which is provided as part of the IBM 2212's one-price package¹, offers proven, standards-based interoperability for routing, security services, legacy application support, and network integrity. AIS carries licensed program number 5639-F73 and has the following components:

- Operational code and SNMP agent functions
- The command-line user interface, which allows you to configure, monitor, diagnose, and use the IBM 2212 Access Utility base code that is installed on the device.

Also provided is a Configuration Program. The Configuration Program is a graphical user interface that allows you to configure the IBM 2212 from a workstation. The Configuration Program includes error checking and online help information.

This chapter lists the features and protocols supported by Access Integration Services. A full explanation of these features and protocols along with instructions for their configuration and use are available in:

- *Access Integration Services Using and Configuring Features*
- *Access Integration Services Software User's Guide*
- *Access Integration Services Protocol Configuration and Monitoring Reference Volumes 1 and 2.*

¹ Adapters and cables are priced separately.

Software Code Loads

Models 10F and 40F are preloaded with Standard code. Models 15F and 45F are preloaded with High-Performance code. Models 10H and 40H are preloaded with Enterprise code. Models 15H and 45H are preloaded with High-Performance Enterprise code. The Standard, High-Performance, Enterprise, and High-Performance Enterprise code loads support the features and protocols listed in Table 3-1 on page 3-2. The features available only in the Enterprise and High-Performance Enterprise code include:

- Thin Server
- TN3270e Server
- Branch Extender
- Dependent LU Requester (DLUR)
- Enterprise Extender
- Extended Border Node
- High-performance routing (HPR)
- Network Node (NN)

The Web Server Cache feature is available in Models x5x only. The web server cache feature is not available in the standard, high-performance, enterprise, or high-performance enterprise code loads. The web server cache feature is available in a separate code load.

Obtaining AIS

Software is preloaded on the IBM 2212 at the factory. (Note that if you purchase the IBM 2212 through an IBM reseller, you may have code loaded at the reseller rather than at the factory.) The Configuration Program is also shipped with each software or hardware order.

Code loads are also available over the Internet from:

<http://www.networking.ibm.com/support/downloads/2212>

The Configuration Program is available over the Internet at:

<http://www.networking.ibm.com/support/downloads/2212>

In addition, versions of the standard and enterprise loads with data encryption support are available on the Web at:

<http://www.networking.ibm.com/support/downloads/2212>

Availability of a particular encryption option depends upon the import/export restrictions in your country.

Chapter 5. Physical Planning and Prerequisites

Placement Options

The IBM 2212 can be placed on a table top or in a rack.

Table Top

If the IBM 2212 is placed on a table top, the table must meet the requirements for service and operating clearances listed under "Service Clearances" on page 5-2.

Rack

If you choose rack-mounting, you must provide the rack; it is not provided with the IBM 2212.

You can use any EIA standard 19-inch rack. The attachment holes along each side of a rack are usually divided into units of measure called *EIA units*. Each EIA unit equals 44.5 mm (1.75 in.).

The rack can be open or closed. However, if you choose a closed rack, you must make sure that enough air flows through the IBM 2212. Covers on the front of the rack that would not let air reach the IBM 2212 must be removed or modified to let air pass. Similarly, unvented rear rack covers that would not let air exit the IBM 2212 or that would cause back pressure to build up from several machines must not be used.

Preparing the Machine Area

To prepare the area where the machine will be installed, you need to consider the following requirements:

- The physical dimensions of the machine
- The area that must be left free around the machine for easy access to the cables, connectors, and parts to be replaced.
- Environmental constraints

Access to the Unit

All cable connectors, a set of LEDs, and all adapters are accessible from the same side of the IBM 2212. An additional set of slot-status LEDs are on the side opposite the cable connectors.

Physical Specifications

The dimensions of the IBM 2212 are as follows:

Width

440 mm (17.3 in.) without rack-mounting flange
480 mm (18.9 in.) with rack-mounting flange

Depth

305 mm (12 in.)

Height

Models 1xx: 44.4 mm (1.75 in.), or 1U
Models 4xx: 89 mm (3.5 in.), or 2U

Weight

Models 1xx weigh approximately 4.54 kg (10 lb) when fully populated.

Models 4xx weigh approximately 8 kg (18 lb) when fully populated

Service Clearances

You must leave free space for service around the machine as follows:

Front 750 mm (30 in.)

Sides For Models 4xx: 3 in.

Rear

- For Models 1xx: 3 in.
- For Models 4xx: 3 in.

Airflow

A blower and a fan are installed in each unit and can generate the following airflow:

- IBM 2212 Models 1xx: 0.24 m³/min.
- IBM 2212 Models 4xx: 0.50 m³/min.

Operating Environment

Temperature 10°C to 40°C (50°F to 105°F)

Relative Humidity 8% to 80%

Max Wet Bulb 27°C (80°F)

Altitude 2133 meters (7000 feet)

Lightning Protection

The power supplies of the IBM 2212 are protected against lightning.

Contact an electrical contractor to determine if lightning protection is needed for your power distribution system.

CPCI Adapter Specifications

Compact Peripheral Component Interconnect (CPCI) adapter slots are 5.25-in (133 mm) wide for 3U adapters. CPCI adapter slots are 10.5-in (266 mm) wide for 6U adapters.

Performance

IBM 2212 Models 10x and 40x, with a standard system card, operate with a Motorola MPC860 with a PowerPC processor core. These models of the IBM 2212 provide support for up to 128 MB of DRAM.

The IBM 2212 Models 10x and 40x with a high-performance system card feature installed, and Models 15x and 45x use an IBM PowerPC 740. The IBM PowerPC 740 provides support for up to 512 MB of DRAM.

See the Internet at <http://www.networking.ibm.com/2212/2212perf.html> for IBM 2212 performance details.

Power Supply

The IBM 2212 power supply uses a voltage sensing system that converts line current of 100-240 volts ac, 50/60 Hz single-phase to dc input as required by the system card, the adapters and the fan.

Models 1xx provide a power supply capacity of up to 65-W.

Models 4xx provides power supply capacity of up to 150-W output.

Power Supply Requirements

For Models 1xx of the IBM 2212, the ac power source must be able to supply:

- 100 to 240 V ac (nominal voltage)
- 50 or 60 Hz
- Single phase
- 0.125 kVA power
- 40 amps peak inrush current for one quarter cycle per supply

For Models 4xx of the IBM 2212, the ac power source must be able to supply:

- 100 to 240 V ac (nominal voltage)
- 50 or 60 Hz
- Single phase
- 0.3 kVA power
- 40 amps peak inrush current for one quarter cycle per supply

Power Cord Characteristics

The ac power cord is shielded and is available with a country-dependent plug. For each of the cords listed in Table 5-1, find its plug type in Figure 5-1 on page 5-5 by comparing *index* numbers. The index number is displayed below each plug type in Figure 5-1.

Table 5-1. AC Power Cords and Power Plug Standards

Index	Feature Code	Part Number	Countries	Power Cord	Plug Standard
1	8846	1838578	Bolivia, Brazil, Ecuador, Canada, Japan, Peru, Philippines, Taiwan, Thailand, Venezuela, United States	10 A, 250 V, 2.7 m (9 ft)	NEMA WD-1 6-15P
2	8835	6952303	Bolivia, Brazil, Canada, Colombia, Ecuador, Japan, Mexico, Panama, Peru, Philippines, Saudi Arabia, South Korea, Taiwan, United States (except Chicago), Venezuela	10 A, 125 V, 2.7 m (9 ft)	NEMA WD-1 5-15P
2	8837	1838579	United States (Chicago only)	10 A, 250 V, 1.8 m (6 ft)	NEMA WD-1 6-15P
2	8836	6952304	United States (Chicago only)	10 A, 125 V, 1.8 m (6 ft)	NEMA WD-1 5-15P
2	8848	13F9968	Thailand — inline plug only	10 A, 250 V, 1.8 m (6 ft)	NEMA WD-1 5-15P
3	8838	13F9988	Austria, Belgium, Brazil, China, Finland, France, Germany, Greece, Indonesia, Macao, Netherlands, Norway, Portugal, Saudi Arabia, South Korea, Spain, Sweden, Turkey	10 A, 250 V, 2.7 m (9 ft)	CEE7 VII
4	8840	14F0042	Brunei, China, Hong Kong, India, Ireland, Kuwait, Malaysia, Singapore, South Africa, United Arab Emirates, United Kingdom	10 A, 250 V, 2.7 m (9 ft)	BS 1363
5	8842	14F0060	Switzerland, Liechtenstein	10 A, 250 V, 2.7 m (9 ft)	SEV 24507
6	8844	14F0078	Chile, Italy	10 A, 250 V, 2.7 m (9 ft)	CEI 23-16
7	8839	14F0006	Denmark	10 A, 250 V, 2.7 m (9 ft)	Normblad 4
8	8841	14F0096	Israel	10 A, 250 V, 2.7 m (9 ft)	SII-32-1971
9	8845	13F9948	Argentina, Australia, Brazil, China, Colombia, New Zealand, Paraguay, Uruguay	10 A, 250 V, 2.7 m (9 ft)	AS 3112-1981 NZS 198
10	8843	14F0024	Bangladesh, Myanmar, Pakistan, South Africa, Sri Lanka	10 A, 250 V, 2.7 m (9 ft)	SABS 164 BS 563

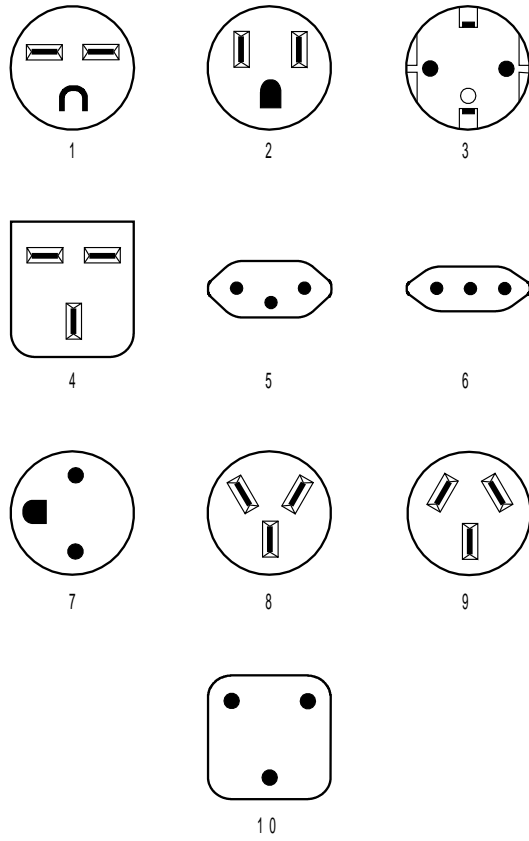

Figure 5-1. AC Power Cord Plugs by Country

Hardware and Software Requirements for the Configuration Program

Table 5-2 lists the minimum requirements for the operating systems supported by the configuration program.

Table 5-2. Configuration Program Requirements for Supported Operating Systems

Requirement	IBM AIX®	IBM Operating System/2®	Microsoft® Windows® 95 or Windows NT®
Workstation	RS/6000® Model 250/410 or higher with minimum 80-Mhz CPU	IBM-compatible PC with Intel® Pentium® 166-MHz or higher processor (see Note 1)	IBM-compatible PC with Intel Pentium 166-MHz or higher processor (see Note 1)
RAM (minimum)	64 MB	48 MB	48 MB
CD-ROM	yes	yes	yes
Free Disk Space	54 MB Additionally, you will need 1 to 3 MB for each configuration file.	37 MB Additionally, you will need 1 to 3 MB for each configuration file.	54MB Additionally, you will need 1 to 3 MB for each configuration file.
Swapper Size	N/A	10 MB	N/A
Display (minimum)	Graphics (1024 x 768 x 256 colors)	SVGA (1024 x 768 x 256 colors)	SVGA (1024 x 768 x 256 colors)
Mouse	3-button	2-button (see Note 2)	2-button (see Note 2)
Software	AIX for RS/6000 V4.1.5 or higher AIX Windows Environment/6000	OS/2® 3.0 or higher IBM TCP/IP 1.2.1 for OS/2 or higher	Microsoft Windows 95 or Windows NT

Notes:

1. More memory and faster processors improve the program's performance.
2. Functionally equivalent to a 3-button mouse.
3. You must make sure that TCP/IP is **installed** and **running** before using the "Single Send or Retrieve" or "Multiple Send or Retrieve" functions. On MS Windows platforms, the configuration program will hang if TCP/IP is not installed and running.

Tested Modems

A modem for remote services access is always recommended. Using a modem enables IBM service personnel to dial into your IBM 2212 for faster service. The following modems have been tested for use with the IBM 2212:

- IBM 7852, Model 400
- Zoom/FaxModem 56Kx
- Atlas 33.6 External PC Data/Fax Modem
- U.S. Robotics 56K Sportster Modem

You can use equivalent modems, with a minimum data transfer rate of 2400 line speed, with the IBM 2212.

For instructions on how to set these modems up to operate with your IBM 2212, see the general information technical tips available at:

<http://www.networking.ibm.com/support/2212>

Note: Please note that IBM is not endorsing or warranting performance of any particular modem or manufacturer.

You will also need to provide an analog telephone connection to the modem. The default line speed of the serial port is 19.2 Kbps.

Network Server Requirements

If you choose a compact flash model of the IBM 2212 instead of a hard drive model, you will need a network server for the dump information, logs, and configuration files that your IBM 2212 is creating and using. Both compact flash and hard drive models require a network server for loading new code images. The available space on the server will need to be sufficient to hold dumps, logs, new code images, and configuration files. The following rules of thumb apply:

- For a single dump, you will need space equivalent to the size of the IBM 2212's DRAM: for example, 64 MB, 96 MB, 128 MB, 192 MB, 256 MB, or 512 MB. Depending upon how you choose to configure dumping, you may need space for up to 3 dumps. The estimate given here assumes an uncompressed dump.
- For new code loads, provide 15-20 MB to allow for growth.
- Requirements for log files can vary widely, but 40- to 50 MB are recommended, especially if you are using the Remote Logging function of the Event Logging System (ELS) or transferring ELS messages and packet trace data from a hard drive or memory buffer.
- For configuration files, 512 KB per file. For the maximum software configuration, 4 MB.

Location of the network server: To support dumping, the network server must be accessible over TFTP via a local Token-Ring or Ethernet segment attached to the IBM 2212. (For normal operation as a configuration server, the server can be located in any location that can be accessed via an IP routed path.)

Note: If you wish to be prepared for performing software recovery over the service port but do not have a LAN-attached network server that you can use for software recovery code load purposes, then you must have a workstation that supports SLIP or ZMODEM.

Chapter 6. Configuration and Monitoring Tools

Accessing the IBM 2212 enables you to install the operational software and to configure, monitor, control, and maintain the router.

You can access the IBM 2212 using following configuration and monitoring tools:

- The Access Integration Services Configuration Program
- OPCON
- The service recovery interface
- Bootstrap menus
- The Nways® Manager family of management products.

You can also use the command line interface to configure the IBM 2212. Each of these tools is described in the sections that follow.

Access Integration Services Configuration Program

The Configuration Program provides a user-friendly way of configuring the IBM 2212 offline through a graphical user interface. The Configuration Program runs installed in a workstation that stands alone or attaches to the IBM 2212 remotely or locally. Instructions for attaching the workstation to the IBM 2212 are provided in the *2212 Access Utility Installation and Initial Configuration Guide*, and instructions for using the Configuration Program are provided in the *Configuration Program User's Guide for Nways Multiprotocol Access, Routing and Switched Services*.

OPCON

OPCON, or the Operator Console, provides local and remote configuration, problem determination, and management functions for the router's hardware and software. OPCON appears when you Telnet into the service port or attach an ASCII terminal or terminal emulator to the service port. OPCON can control or stop system processes and provides statistics for packets forwarded, memory utilization, uptime, restart or reload information, error counting, and routing table protocol status.

Refer to the *2212 Access Utility Service and Maintenance Manual* for an explanation of this interface's command structure and requirements.

Service Recovery Interface

Use the Service Recovery Interface if you need to recover the operational code or update the bootstrap code on the IBM 2212's system card. The *2212 Access Utility Service and Maintenance Manual* explains how to use service recovery functions.

Bootstrap Menus

Use the Bootstrap Menu interface when you need to test the basic functions of the system card. See the section on accessing and using the IBM 2212 Bootstrap Menu in the *IBM 2212 Service and Maintenance Guide* for a full description of this TTY interface.

Network Management

The IBM 2212 supports the open network management standard, SNMP and is designed to be managed using SNMP management applications. IBM's Nways Manager family of products for Windows NT, AIX, and HP-UX provide SNMP applications for managing and monitoring the IBM 2212. These applications include:

- Nways Manager for AIX
- Nways Manager for HP-UX
- Nways Workgroup Manager for Windows NT

These separately purchasable applications are custom-designed to provide management function for the IBM 2212. Information regarding these applications is available on the World Wide Web at:

<http://www.networking.ibm.com/netmgt>

Chapter 7. Network Planning

This chapter contains the following sections:

- “Planning for ISDN”
- “Planning for Remote Access” on page 7-4
- “Planning for Thin Server” on page 7-5
- “Planning for Network Dispatcher” on page 7-6
- “Planning for Virtual Private Networks” on page 7-6

Planning for ISDN

The ISDN interface provides a scalable solution for customers who require high-capacity dial backup between remote sites or cost-effective consolidation of dozens of leased line connections. ISDN interfaces are also used for implementing the DIALs remote access function.

Planning for ISDN in the IBM 2212

The IBM 2212 Models 4xx have four adapter slots, which can be populated with any combination of the ISDN adapters listed in Table 7-1.

The IBM 2212 Models 1xx have one adapter slot, which can contain one of the ISDN adapters in the table.

For maximum flexibility, line service on each port can be individually provisioned.

Table 7-1. Number of B-Channels per ISDN Adapter

Number of B-Channels Supported	Adapter	Feature Code
23	1-port ISDN PRI T1/J1	3106
30	1-port ISDN PRI E1	3107
46	2-port ISDN PRI T1/J1	3108
60	2-port ISDN PRI E1	3109
4	2-port ISDN BRI-U*	3104
4	2-port ISDN BRI-S/T*	3105

Note: For the ISDN BRI adapters, X.25 on the D-channel is also supported.

Planning for ISDN with your Service Provider

Contact your telephone company to plan for T1/J1, E1, and line service. The sections that follow list information to provide and gather.

Information to Provide to your Telephone Company

When leasing lines from your public telephone service provider, provide the following information for ISDN connections:

Service on the line

Either Primary Rate Interface (PRI) ISDN or Basic Rate (BRI) ISDN

Telephone numbers per line

The number of telephone numbers to associate with each line.

Hunt groups

A hunt group associates one phone number with several channels on a line. When a user dials in, connection occurs over any channel that is free. Note that a single hunt group can be set up over multiple T1 or E1 lines; furthermore, it is not necessary for all hunt group lines to connect into the same IBM 2212. As an alternative to a hunt group, each of the 23 T1 or 30 E1 bearer channels in a line can be called using separate phone numbers.

Number of lines

You will need one line for each port (to determine how many ports are needed, see Table 7-1 on page 7-1).

Service agreement

An E1 or T1 line provides continuous signaling. Some service providers detect when signaling is broken and terminate service to the line. Specify in your service agreement the conditions under which it is appropriate to terminate line support.

Information to Gather from Your Telephone Company

You will need to gather the following information from your telephone company:

For ISDN BRI Connections:

Note: The ISDN BRI U interface is for use only in North America. The ISDN BRI S/T interface is for worldwide usage. S/T can be used in North America with external NT1.

Switch variant

The kind of switch your telco will be using to connect to the 2212 ISDN BRI line. The IBM 2212 supports:

- AT&T 5ESS (United States)
- Northern Telecom DMS 100 (United States)
- USNI1 (United States National ISDN1)
- USNI2 (United States National ISDN2)
- NET 3 (European ETSI)
- INS 64 (Japan)
- VN3 (France Telecom)
- AUS TS 013 (Australia)
- I.430

Telephone numbers

SPID, TEI (auto or fixed), and directory numbers.

For ISDN PRI Connections:

Switch variant

The kind of switch your telco will be using to connect to the 2212 ISDN PRI line. The IBM 2212 supports:

- AT&T 5ESS (United States)
- AT&T 4ESS
- Northern Telecom (DMS PRI)
- Australia (AUSTEL) TS-014
- INS-Net 1500 (Japan, NTT)
- National ISDN 2
- NET 5 (Euro-ISDN, ETSI)

I.431 (for T1 PRI, not E1 PRI)

Telephone numbers

Assigned by the telco to your channels.

Line type

In Europe, South America, and certain other countries, use an E1 line. In Canada, the U.S., and Mexico, use a T1 line. Japan requires a T1 or J1 line.

Line build out (LBO)

Line build out is the voltage level on the connector that terminates your line at the 2212. LBO accounts for the distance between the 2212 and the telco, the quality of the line, and the intermediate amplification as specified in dB.

Line coding

For T1, Bipolar 8 Zero Substitution (B8ZS). For E1, High Density Bipolar 3 (HDB3). Alternate Mark Inversion (AMI) for both.

Time slot inversion

Enabled or disabled Zero Byte Time Slot Inversion (ZBTSI).

Data link

Super frame (D4) and extended super frame (ESF) are supported. For ESF, your service subscription will specify ANSI-T1.403, ANSI-IDLE, or AT&T IDLE.

CRC4

Enabled or disabled E1 CRC4 packet checking mechanism.

Publications

More information about ISDN in the IBM 2212 is available in these publications:

- The *2212 Access Utility Installation and Initial Configuration Guide* explains how to install the IBM 2212 and its adapters.
- The *Access Integration Services Software User's Guide* provides details about configuring the IBM 2212 for use with ISDN PRI T1/E1/J1, ISDN BRI S/T, and ISDN BRI-U adapters.

Planning for Remote Access

The IBM 2212 supports remote access through its Dial-In Access to LANs (DIALs) feature. Remote users can dial-in to access the corporate data center:

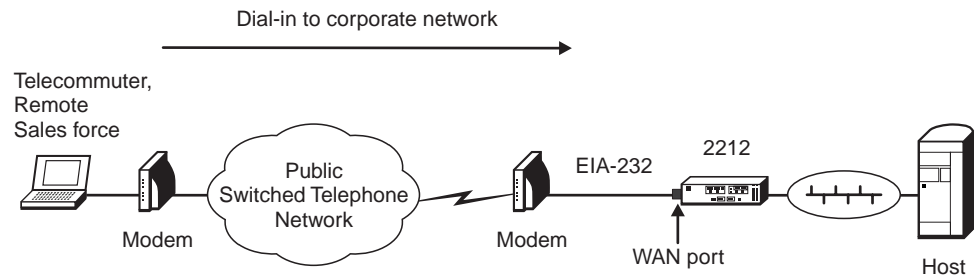

Figure 7-1. Dialing in to Reach the Corporate Data Center

And on-site workers can dial out to reach off-site resources:

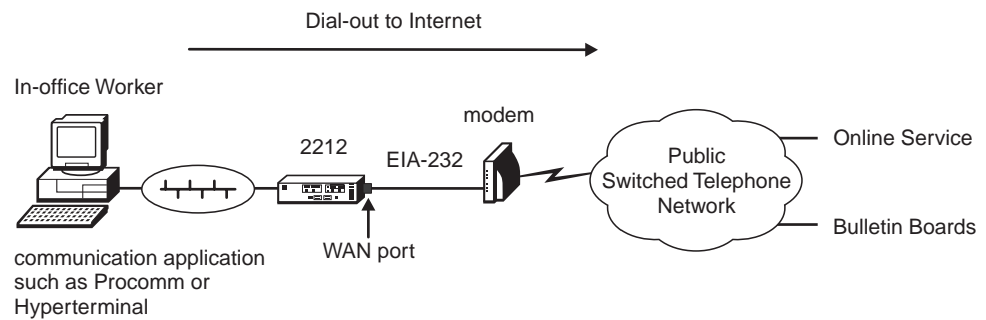

Figure 7-2. Dialing out to Reach Off-Site Resources

DIALs is supported on IBM 2212 integrated WAN ports, 4-port WAN PMC, 4-port WAN CPCI, all ISDN BRI adapters, all ISDN PRI adapters, 4-port analog 56K modem CPCI, and all digital modem adapters.

To use DIALs on a WAN port, you will need a Hayes AT command set-compatible modem supporting modulations up to V.90 (56 Kbps). You will also need an EIA-232 DTE cable such as the EIA-232D/V.24 Cable (FC 2321, PN 55H7756), listed in "Cables" on page 2-12.

Planning for Thin Server

As mentioned in "Determining Whether to Order a Hard Drive or Compact Flash Model" on page 2-3, it is strongly recommended that the Thin Server feature (TSF) be run on a hard drive model of the IBM 2212.

Thin Server is designed to be compatible with other manufacturers' master servers that have Network File System (NFS) support. The Thin Server NFS support has been tested with the following master file servers:

- Windows NT 4 running Network Station Manager V1R3
- AIX 4.3.0.0 running Network Station Manager V1R3

The AS/400 supports the Thin Server's Remote File System (RFS) protocol. The Thin Server RFS support has been tested with the following master file servers:

- OS/400 V4R2 running Network Station Manager V1R3
- OS/400 V4R2 running Network Station Manager V1R3 or OS/400 V3R7 running Network Station Manager V1R2.5

However, once the network station is booted and the user has logged on to the network, then the user can connect to other servers in the network.

Thin Server is also designed to be compatible with other manufacturers' network stations running TFTP or NFS. The Thin Server has been tested with IBM Network Stations.

The number of sessions supported by the Thin Server depends on the network load, the desired performance characteristics of the Network Station, and the protocols being used. If the master file server protocol is NFS then there is no maximum number of Network Stations that can be connected. If the master file server protocol is RFS then no more than 200 Network Stations can be connected at any one time. The desired performance and network load are more dependent on individual network considerations and individual perceptions of acceptable performance. In general, no more than 30 Network Stations should be active at any given time.

Thin Server can be managed using SNMP management tools.

For more information about using the IBM Network Station, see the following Web sites and documents:

- The IBM Network Station Home Page:
<http://www.pc.ibm.com/networkstation/station/>
- The IBM Network Station publications:
<http://www.ibm.com/nc/pubs>
- *IBM Network Station Manager Installation and Use*, SC41-0664-01
- *IBM Network Station Manager for AS/400*, SC41-0632

Planning for Network Dispatcher

The Network Dispatcher function balances traffic load among multiple TCP or UDP servers as illustrated in Figure 1-7 on page 1-11 and provides high-availability features such as database synchronization, failure detection, and IP Takeover to re-direct traffic to a standby IBM 2212.

IBM offers the Network Dispatcher feature not only for the IBM 2212, but also in the 2210 Nways Multiprotocol Router, 2216 Nways Multiaccess Connector Model 400 and the Network Utility.

Network Dispatcher can be run in the same IBM 2212 with a target TN3270E server. Servers must be on a local subnet with the Network Dispatcher machine, zero hops away.

For more information about Network Dispatcher, see *Access Integration Services Using and Configuring Features*.

Planning for Virtual Private Networks

The IBM 2212 provides cryptographically strong multiprotocol virtual private networks (VPNs) to secure confidential information flows over untrusted networks. IP Security (IPSec) provides IP network layer security, while Layer 2 Tunneling Protocol (PPTP), and Layer 2 Forwarding (L2F) provide multiprotocol tunneling over IP.

For VPNs with quality of service requirements, the IBM 2212 integrated policy management simplifies configuration of VPNs, Differentiated Services (DS), and ReSerVation Protocol (RSVP).

VPN protocols are supported over all IP enabled interfaces on all ports and adapters. VPN capacity planning information is available at:

<http://www.networking.ibm.com/2212/2212perf.html>

The support that the IBM 2212 provides for VPNs and for virtual private dial-up networks (VPDNs) are strong components of IBM's overall strategy for ensuring the security of your organization's data. However, they are only components of a larger solution. IBM's security solutions encompass multi-platform VPN-enabled clients and servers, routers, controllers, ISP services, and consulting services. For more information about creating an end-to-end virtual private network, visit the IBM Security Services Web site at

<http://www.ibm.com/security/html/consult.html>

Appendix A. Initial Configuration Worksheet

This appendix contains an initial configuration planning worksheet that will help you to plan for configuration.

Make one copy of page A-2 for each IBM 2212 to be installed in your network. The information you fill in will be used by the person installing your IBM 2212 to define the interface to the server where configuration data is stored. The instructions for performing the initial configuration are in the *IBM 2212 Access Utility Installation and Initial Configuration Guide*.

Notes:

1. To perform initial configuration on the IBM 2212 or to add an interface that communicates with the Configuration Tool, you must use the **add device** command at the command-line interface's `Config (only)>` prompt. If an integrated WAN port on the IBM 2212 system card is being used as the interface to the server, you do not need to fill out the "add device" information on the Initial Configuration worksheet.
2. The default interface on the integrated WAN ports or 4-port WAN adapter is PPP. If you need to use a different data link type (for example, Frame Relay), use the **set data link** command.

When performing a basic, initial configuration of the IBM 2212 using the quick configuration, you can answer "no" to questions about configuring bridging, IPX, and Digital Network Architecture (DNA).

Table A-1. Initial Configuration Worksheet

Completed by: _____
 IBM 2212 Name: _____

Date: _____

Fill-in the slot, port, and interface information for the LAN/WAN interface that will communicate with the server where the configuration files reside. This interface will be defined at the command line interface via the **add device** command.

Adapter	Slot and port	Interface number
Integrated WAN ports (4) (See Note 1)	Port 1 Port 2 Port 3 Port 4	Interface 0 Interface 1 Interface 2 Interface 3
1-port Token-Ring PMC		
2-port Token-Ring CPCI Adapter	Slot: _____ Port: _____ Port: _____	Interface: _____ Interface: _____
1-port 10/100 Mbps Ethernet PMC		
2-port 10/100 Mbps Ethernet CPCI Adapter	Slot: _____ Port: _____ Port: _____	Interface: _____ Interface: _____
1-port ISDN PRI T1/J1 CPCI Adapter	Slot: _____	
2-port ISDN PRI T1/J1 CPCI Adapter	Slot: _____ Port: _____ Port: _____	Interface: _____ Interface: _____
1-port ISDN PRI E1 CPCI Adapter	Slot: _____	
2-port ISDN PRI E1 CPCI Adapter	Slot: _____ Port: _____ Port: _____	Interface: _____ Interface: _____

2-port ISDN BRI-U CPCI Adapter	Slot: _____ Port: _____ Port: _____	Interface: _____ Interface: _____
2-port ISDN BRI-S/T CPCI Adapter	Slot: _____ Port: _____ Port: _____	Interface: _____ Interface: _____
4-port WAN CPCI Adapter	Slot: _____ Port: _____ Port: _____ Port: _____ Port: _____	Interface: _____ Interface: _____ Interface: _____ Interface: _____
4-port Analog 56K Modem Adapter	Slot: _____ Port: _____ Port: _____ Port: _____ Port: _____	Interface: _____ Interface: _____ Interface: _____ Interface: _____
Compression/Encryption CPCI Adapter	Slot: _____	Coprocessor: _____
4-port WAN PMC Adapter	Slot: _____ Port: _____ Port: _____ Port: _____ Port: _____	Interface: _____ Interface: _____ Interface: _____ Interface: _____

2-port Analog FXS Voice/Fax CPCI	Slot: _____ Port: _____ Port: _____	Interface: _____ Interface: _____
2-port Analog FXO Voice/Fax CPCI	Slot: _____ Port: _____ Port: _____	Interface: _____ Interface: _____
2-port Analog E&M Voice/Fax CPCI	Slot: _____ Port: _____ Port: _____	Interface: _____ Interface: _____
T1/J1 12-channel Digital Modem Adapter	Slot: _____	Interface: _____
T1/J1 24-channel Digital Modem Adapter	Slot: _____	Interface: _____
E1 12-channel Digital Modem Adapter	Slot: _____	Interface: _____
E1 30-channel Digital Modem Adapter	Slot: _____	Interface: _____

Enter the following IP information for the LAN/WAN interface (configured using the **add device** command) that will communicate with the server where the configuration files are stored.

Configure IP YES

Configure Interface ___ (0-xx)? YES

IP address _____ Address Mask _____

Enable Dynamic Routing? NO

Enable OSPF? NO

Define community with Write_Read_Trap Access? YES

Community Name _____

Do you want to write this configuration? YES

Notes:

1. The four integrated WAN ports on the standard system card do not need to be added; they are added automatically by the IBM 2212 software.
2. You do not need to fill in a slot number when configuring Models 1xF and 1xH.

Appendix B. Notices

References in this publication to IBM products, programs, or services do not imply that IBM intends to make these available in all countries in which IBM operates. Any reference to an IBM product, program, or service is not intended to state or imply that only IBM's product, program, or service may be used. Subject to IBM's valid intellectual property, or other legally protectable rights, any functionally equivalent product, program, or service that does not infringe any of IBM's intellectual property rights may be used instead of the IBM product, program, or service. The evaluation and verification of operation in conjunction with other products, except those expressly designated by IBM, are the user's responsibility.

IBM may have patents or pending patent applications covering subject matter in this document. The furnishing of this document does not give you any license to these patents. You can send license inquiries, in writing, to:

IBM Director of Licensing
IBM Corporation
North Castle Drive
Armonk, NY 10504-1785
U.S.A.

Notice to Users of Online Versions of This Book

For online versions of this book, we authorize you to:

- Copy, modify, and print the documentation contained on the media, for use within your enterprise, provided you reproduce the copyright notice, all warning statements, and other required statements on each copy or partial copy.
- Transfer the original unaltered copy of the documentation when you transfer the related IBM product (which may be either machines you own, or programs, if the program's license terms permit a transfer). You must, at the same time, destroy all other copies of the documentation.

You are responsible for payment of any taxes, including personal property taxes, resulting from this authorization.

THERE ARE NO WARRANTIES, EXPRESS OR IMPLIED, INCLUDING THE WARRANTIES OF MERCHANTABILITY AND FITNESS FOR A PARTICULAR PURPOSE.

Some jurisdictions do not allow the exclusion of implied warranties, so the above exclusion may not apply to you.

Your failure to comply with the terms above terminates this authorization. Upon termination, you must destroy your machine-readable documentation.

Trademarks

The following terms used in this publication are trademarks or service marks of IBM Corporation in the United States or other countries, or both:

AIX	APPN	IBM
Operating System/2	Nways	Network Station
OS/2	PowerPC (logo)	RS/6000

Microsoft, Windows, Windows NT, and the Windows logo are trademarks or registered trademarks of Microsoft Corporation.

Intel and Pentium are trademarks of Intel Corporation in the United States and/or other countries.

Other company, product, and service names may be trademarks or service marks of others.

Glossary

This glossary includes terms and definitions from:

- The *IBM Dictionary of Computing* (New York; McGraw-Hill, Inc., 1994).
- The *American National Standard Dictionary for Information Systems*, ANSI X3.172-1990, copyright 1990 by the American National Standards Institute (ANSI). Copies may be purchased from the American National Standards Institute, 11 West 42nd Street, New York, New York 10036. Definitions are identified by the symbol (A) after the definition.
- The *Information Technology Vocabulary* developed by Subcommittee 1, Joint Technical Committee 1, of the International Organization for Standardization and the International Electrotechnical Commission (ISO/IEC JTC1/SC1). Definitions of published parts of this vocabulary are identified by the symbol (I) after the definition; definitions taken from draft international standards, committee drafts, and working papers being developed by ISO/IEC JTC1/SC1 are identified by the symbol (T) after the definition, indicating that final agreement has not yet been reached among the participating National Bodies of SC1.
- The Network Working Group Request for Comments: 1208.

The following cross-references are used in this glossary:

Contrast with: This refers to a term that has an opposed or substantively different meaning.

Synonym for: This indicates that the term has the same meaning as a preferred term, which is defined in its proper place in the glossary.

Synonymous with: This is a backward reference from a defined term to all other terms that have the same meaning.

See: This refers you to multiple-word terms that have the same last word.

See also: This refers you to terms that have a related, but not synonymous, meaning.

A

A. Ampere.

ac. Alternating current.

active. (1) Operational. (2) Pertaining to a node or device that is connected or is available for connection to another node or device.

Advanced Peer-to-Peer Networking (APPN) network node. A node that offers a broad range of end-user services and that can provide the following:

- Distributed directory services, including registration of its domain resources to a central directory server
- Topology database exchanges with other APPN network nodes, enabling network nodes throughout the network to select optimal routes for LU-LU sessions based on requested classes of service
- Session services for its local LUs and client end nodes
- Intermediate routing services within an APPN network

agent. A system that assumes an agent role.

analog. (1) Pertaining to data consisting of continuously variable physical quantities. (A) (2) Contrast with *digital*.

AMI. Alternate Mark Inversion.

ANSI. American National Standards Institute.

AppleTalk. A network protocol developed by Apple Computer, Inc. This protocol is used to interconnect network devices, which can be a mixture of Apple and non-Apple products.

APPN node. Advanced Peer-to-Peer Networking (APPN) node.

attachment unit interface (AUI). In a local area network, the interface between the medium attachment unit and the data terminal equipment within a data station. (I) (A)

AUI. Attachment unit interface.

autonomous system (AS). A group of networks and routers that use the same interior gateway protocol and for which one administrative authority has responsibility.

B

Bc. Committed burst size.

Be. Excess burst size.

bootstrap. (1) A short program that is permanently resident or easily loaded into a computer and whose execution brings a larger program, such as an operating system or its loader, into memory. (A) (2) To execute a bootstrap. The term "bootstrapping" is also used for

translating a compiler by using itself or a previous version as the translator. (A) (3) Synonym for initial program load.

bps. Bits per second.

bridge. A functional unit that interconnects multiple LANs (locally or remotely) that use the same logical link control protocol but that can use different medium access control protocols. A bridge forwards a frame to another bridge based on the medium access control (MAC) address.

bridging. In LANs, the forwarding of a frame from one LAN segment to another. The destination is specified by the medium access control (MAC) sublayer address encoded in the destination address field of the frame header.

broadband. A large frequency band allowing different kinds of transmissions, such as coded voice, video, and data, at the same time.

BSC. Binary synchronous communication.

C

CAS. Channel associated signaling.

CCITT. International Telegraph and Telephone Consultative Committee. This was an organization of the International Telecommunication Union (ITU). On 1 March 1993 the ITU was reorganized, and responsibilities for standardization were placed in a subordinate organization named the Telecommunication Standardization Sector of the International Telecommunication Union (ITU-TS). "CCITT" continues to be used for recommendations that were approved before the reorganization.

CCS. (1) common channel signaling (2) change control server.

CDB. Configuration database.

CES. Circuit emulation service.

channelization. The process of breaking the bandwidth on a communication line into a number of channels, possibly of different size. Also called *time division multiplexing* (TDM).

CIR. Committed information rate.

circuit. (1) One or more conductors through which an electric current can flow. See *physical circuit* and *virtual circuit*. (2) A logic device.

circuit switching. (1) A process that, on demand, connects two or more data terminal equipment (DTEs) and permits the exclusive use of a data circuit between them until the connection is released. (I) (A) (2) Synonymous with *line switching*.

CMIP. Common Management Information Protocol.

CMIS. Common Management Information Services.

CMOT. CMIP over TCP/IP.

CNM. Communication network management.

configuration. (1) The manner in which the hardware and software of an information processing system are organized and interconnected. (T) (2) The devices and programs that make up a system, subsystem, or network.

connection. In data communication, an association established between functional units for conveying information. (I) (A)

CP. Control point.

CPCI. Compact peripheral component interconnect.

CRC. Cyclic redundancy check.

CSU. Channel Service Unit.

D

data circuit. (1) A pair of associated transmit and receive channels that provide a means of two-way data communication. (I) (2) See also *physical circuit* and *virtual circuit*.

Notes:

1. Between data switching exchanges, the data circuit may include data circuit-terminating equipment (DCE), depending on the type of interface used at the data switching exchange.
2. Between a data station and a data switching exchange or data concentrator, the data circuit includes the data circuit-terminating equipment at the data station end, and may include equipment similar to a DCE at the data switching exchange or data concentrator location.

data circuit-terminating equipment (DCE). In a data station, the equipment that provides the signal conversion and coding between the data terminal equipment (DTE) and the line. (I)

Notes:

1. The DCE may be separate equipment or an integral part of the DTE or of the intermediate equipment.
2. A DCE may perform other functions that are usually performed at the network end of the line.

data link control (DLC). A set of rules used by nodes on a data link (such as an SDLC link or a token ring) to accomplish an orderly exchange of information.

data link switching (DLSw). A method of transporting network protocols that use IEEE 802.2 logical link control (LLC) type 2. SNA and NetBIOS are examples of protocols that use LLC type 2. See also *encapsulation* and *spoofing*.

data terminal equipment (DTE). That part of a data station that serves as a data source, data sink, or both. (I) (A)

data terminal ready (DTR). A signal to the modem used with the EIA 232 protocol.

dc. Direct current.

DCD. DC distribution (module).

DCE. Data circuit-terminating equipment.

DC48. DC power input type -48V.

dependent LU requester (DLUR). An APPN end node or an APPN network node that owns dependent LUs, but requests that a dependent LU server provide the SSCP services for those dependent LUs.

device. A mechanical, electrical, or electronic contrivance with a specific purpose.

digital. (1) Pertaining to data that consist of digits. (T)
(2) Pertaining to data in the form of digits. (A) (3) Contrast with *analog*.

DLCI. Data link connection identifier.

DLS. Data link switching.

DLUR. Dependent LU requester.

DTE. Data terminal equipment. (A)

DTMF. Dual-tone modulation frequency.

DTR. Data terminal ready.

E

E&M. Earth & mark.

EIA. Electronic Industries Association.

EIA unit. A unit of measure, established by the Electronic Industries Association, equal to 44.45 millimeters (1.75 inches).

EIA 232. In data communications, a specification of the Electronic Industries Association (EIA) that defines the interface between data terminal equipment (DTE) and data circuit-terminating equipment (DCE), using serial binary data interchange.

Electronic Industries Association (EIA). An organization of electronics manufacturers that advances the technological growth of the industry, represents the views of its members, and develops industry standards.

encapsulation. In communications, a technique used by layered protocols by which a layer adds control information to the protocol data unit (PDU) from the layer it supports. In this respect, the layer encapsulates the data from the supported layer. In the Internet suite of protocols, for example, a packet would contain control information from the physical layer, followed by control information from the network layer, followed by the application protocol data. See also *data link switching (DLSw)*.

ESF. Extended status flags.

Ethernet. A 10-Mbps baseband local area network that allows multiple stations to access the transmission medium at will without prior coordination, avoids contention by using carrier sense and deference, and resolves contention by using collision detection and transmission. Ethernet uses carrier sense multiple access with collision detection (CSMA/CD).

ELS. Event Logging System

F

FAT. File allocation table.

fax. Hardcopy received from a facsimile machine. Synonymous with *teletcopy*.

FDL. Facility Data Link.

flash memory. A data storage device that is programmable, erasable, and does not require continuous power. The chief benefit of flash memory over other programmable and erasable data storage devices is that it can be reprogrammed without being removed from the circuit board.

FR. Frame relay.

FRAD. Frame relay access device.

frame relay. (1) An interface standard describing the boundary between a user's equipment and a fast-packet network. In frame-relay systems, flawed frames are discarded; recovery comes end-to-end rather than hop-by-hop. (2) A technique derived from the integrated services digital network (ISDN) D channel standard. It assumes that connections are reliable and dispenses with the overhead of error detection and control within the network.

frequency. The rate of signal oscillation, expressed in hertz.

FRFH. Frame relay frame handler.

FRTE. Frame relay terminal equipment.

FRU. Field replaceable unit.

FTP. File Transfer Protocol.

FXO. Foreign Exchange Office.

FXS. Foreign Exchange Station.

G

gateway. (1) A functional unit that interconnects two computer networks with different network architectures. A gateway connects networks or systems of different architectures. A bridge interconnects networks or systems with the same or similar architectures. (T) (2) In the IBM Token-Ring Network, a device and its associated software that connect a local area network to another local area network or a host that uses different logical link protocols.

Gbps. Gigabits per second (1 000 000 000 bits per second).

GUI. Graphical user interface.

H

HDLC. High-level data link control.

high-level data link control (HDLC). An access service used over data networks. It uses a non-real-time connection.

HDLC-like data link control, for example:

- Synchronous data link control (SDLC) used with SNA, or
- Link access procedure for D-channel (LAP-D) used with ISDN.

high-performance file system (HPFS). In the OS/2 operating system, an installable file system that uses high-speed buffer storage, known as a cache, to provide fast access to large disk volumes. The file system also supports the coexistence of multiple, active file systems on a single personal computer, with the capability of multiple and different storage devices. File names used with the HPFS can have as many as 254 characters.

high-performance routing (HPR). An addition to the Advanced Peer-to-Peer Networking (APPN) architecture that enhances data routing performance and reliability, especially when using high-speed links.

hot pluggable. Refers to a hardware component that can be installed or removed without disturbing the operation of any other resource that is not connected to, or dependant on, this component.

HPDT. High-Performance Data Transfer.

HPFS. High-performance file system.

hub (intelligent). A wiring concentrator, such as the IBM 8260, that provides bridging and routing functions for LANs with different cables and protocols.

I

IDNX. Integrated Digital Network Exchange.

IEEE. Institute of Electrical and Electronics Engineers.

impedance. The combined effect of resistance, inductance, and capacitance on a signal at a given frequency.

integrated services digital network (ISDN). A digital end-to-end telecommunication network that supports multiple services including, but not limited to, voice and data.

Note: ISDNs are used in public and private network architectures.

interface. (1) A shared boundary between two functional units, defined by functional characteristics, signal characteristics, or other characteristics, as appropriate. The concept includes the specification of the connection of two devices having different functions. (T) (2) Hardware, software, or both, that links systems, programs, or devices.

Intermediate Session Routing (ISR). A type of routing function within an APPN network node that provides session-level flow control and outage reporting for all sessions that pass through the node but whose end points are elsewhere.

International Organization for Standardization

(ISO). An organization of national standards bodies from various countries established to promote development of standards to facilitate international exchange of goods and services, and develop cooperation in intellectual, scientific, technological, and economic activity.

internet. A collection of networks interconnected by a set of routers that allow them to function as a single, large network. See also *Internet*.

Internet. A worldwide network connecting users through autonomous networks in industry, education, government, and research. The Internet network uses Internet Protocol (IP). The major Internet services include electronic mail, FTP, telnet, World Wide Web, and electronic bulletin boards (Usenet). For network interconnection and routing, and Transmission Control Protocol (TCP) for end-to-end control. (A)

Internet Protocol (IP). A connectionless protocol that routes data through a network or interconnected networks. IP acts as an intermediary between the higher protocol layers and the physical network. However, this protocol does not provide error recovery and flow control and does not guarantee the reliability of the physical network.

Internetwork Packet Exchange (IPX). The network protocol used to connect Novell's servers, or any workstation or router that implements IPX, with other workstations. Although similar to the Internet Protocol (IP), IPX uses different packet formats and terminology.

IP. Internet Protocol.

IPX. Internetwork Packet Exchange.

ISDN. Integrated services digital network.

ISM. IBM Solution Manager.

ISMD. IBM Software Manufacturing and Delivery.

ISO. International Organization for Standardization.

ISR. Intermediate session routing.

ITU-T. International Telecommunication Union - Telecommunication (replaces CCITT).

K

Kbps. Kilobits per second (1024 bits per second).

kVA. kilovolt amperes.

L

LAN. Local area network.

LAPD. Link access procedure for D-channel.

LBO. Line build out.

LCS. Logical channel station.

LED. Light-emitting diode.

LIC. Line interface coupler.

Line build out. The voltage level on the RJ-45 connector that terminates your ISDN line at the IBM 2212. LBO accounts for the distance between the IBM 2212 and the telco, the quality of the line, and the intermediate amplification as specified in dB.

line switching. Synonym for *circuit switching*.

link. The combination of the link connection (the transmission medium) and two link stations, one at each end of the link connection. A link connection can be shared among multiple links in a multipoint or token-ring configuration.

link connection. The physical equipment providing two-way communication between one link station and one or more other link stations; for example, a telecommunication line and data circuit-terminating equipment (DCE). Synonymous with *data circuit*.

LMI. Local management interface.

local. Pertaining to a device accessed directly without use of a telecommunication line.

local area network (LAN). (1) A computer network located on a user's premises within a limited geographical area. Communication within a local area network is not subject to external regulations; however, communication across the LAN boundary may be subject to some form of regulation. (T) (2) A network in which a set of devices are connected to one another for communication and that can be connected to a larger network. See also *Ethernet* and *token ring*. (3) Contrast with *metropolitan area network (MAN)* and *wide area network (WAN)*.

M

MAN. Metropolitan area network.

Management Information Base (MIB). (1) A collection of objects that can be accessed by means of a network management protocol. (2) A definition for management information that specifies the information

available from a host or gateway and the operations allowed. (3) In OSI, the conceptual repository of management information within an open system.

MB. Megabyte (1 048 576 bytes).

Mbps. Megabits per second (1 048 576 bits per second).

metropolitan area network (MAN). A network formed by the interconnection of two or more networks which may operate at higher speed than those networks, may cross administrative boundaries, and may use multiple access methods. (T) Contrast with *local area network (LAN)* and *wide area network (WAN)*.

MIB. (1) MIB module. (2) Management Information Base.

modem (modulator/demodulator). (1) A functional unit that modulates and demodulates signals. One of the functions of a modem is to enable digital data to be transmitted over analog transmission facilities. (T) (A) (2) A device that converts digital data from a computer to an analog signal that can be transmitted on a telecommunication line, and converts the analog signal received to data for the computer.

MPC. Multi-Path Channel.

MPC+. High-Performance Data Transfer (HPDT) Multi-Path Channel.

ms. Millisecond (1/1000 second).

N

network. (1) A configuration of data processing devices and software connected for information interchange. (2) A group of nodes and the links interconnecting them.

network architecture. The logical structure and operating principles of a computer network. (T)

Note: The operating principles of a network include those of services, functions, and protocols.

network management. The process of planning, organizing, and controlling a communication-oriented data processing or information system.

NIC. Network Information Center.

NMS. Network management station.

NNI. Network-to-network interface.

non-return-to-zero change-on-ones recording (NRZ-1). A recording method in which the ones are

represented by a change in the condition of magnetization, and zeros are represented by the absence of change. Only the one signals are explicitly recorded. (Previously called *non-return-to-zero inverted, NRZI, recording*.)

NRZ-1. Non-return-to-zero change-on-ones recording.

NSAP. Network service address point.

NSC. Network Support Center.

NVDM. NetView Distribution Manager/6000.

O

OSI. Open systems interconnection.

P

packet loss ratio. The probability that a packet will not reach its destination or not reach it within a specified time.

packet mode operation. Synonym for *packet switching*.

packet switching. (1) The process of routing and transferring data by means of addressed packets so that a channel is occupied only during transmission of a packet. On completion of the transmission, the channel is made available for transfer of other packets. (I) (2) Synonymous with *packet mode operation*. See also *circuit switching*.

PBX. Private branch exchange.

PCM. Pulse code modulation.

PDH. Plesiochronous digital hierarchy.

permanent virtual circuit (PVC). In X.25 and frame relay communications, a virtual circuit that has a logical channel permanently assigned to it at each data terminal equipment (DTE).

physical circuit. A circuit established without multiplexing. See also *data circuit*. Contrast with *virtual circuit*.

PM. Presentation Manager.

PMF. Parameter Management Frame.

PNP. Private numbering plan.

Point-to-Point Protocol (PPP). A protocol that provides a method for encapsulating and transmitting packets over serial point-to-point links.

port. (1) An access point for data entry or exit. (2) A connector on a device to which cables for other devices such as display stations and printers are attached. Synonymous with *socket*. (3) The representation of a physical connection to the link hardware. A port is sometimes referred to as an adapter; however, there can be more than one port on an adapter. There may be one or more ports controlled by a single DLC process. (4) In the Internet suite of protocols, a 16-bit number used to communicate between TCP or the User Datagram Protocol (UDP) and a higher-level protocol or application. Some protocols, such as File Transfer Protocol (FTP) and Simple Mail Transfer Protocol (SMTP), use the same well-known port number in all TCP/IP implementations. (5) An abstraction used by transport protocols to distinguish among multiple destinations within a host machine.

PPP. Point-to-Point Protocol.

private branch exchange (PBX). A private telephone exchange for transmission of calls to and from the public telephone network.

problem determination. The process of determining the source of a problem; for example, a program component, machine failure, telecommunication facilities, user or contractor-installed programs or equipment, environmental failure such as a power loss, or user error.

PRS. Primary reference source.

PSN. Public switched network.

PSTN. Public switched telephone network.

PTM. Packet transfer mode.

PVC. Permanent virtual circuit.

Q

QoS. Quality of service.

R

rack. A metallic structure, with a standard 19-inch width, that houses Nways Switch hardware elements: logic subrack with modules, fan boxes, and power subrack with power units.

real-time processing. The manipulation of data that are required, or generated, by some process while the process is in operation. Usually the results are used to influence the process, and perhaps related processes, while it is occurring.

RETAIN. Remote Technical Assistance Information Network.

ring. See *ring network*.

ring network. (1) A network in which every node has exactly two branches connected to it and in which there are exactly two paths between any two nodes. (T)
(2) A network configuration in which devices are connected by unidirectional transmission links to form a closed path.

route. (1) An ordered sequence of nodes and transmission groups (TGs) that represent a path from an origin node to a destination node traversed by the traffic exchanged between them. (2) The path that network traffic uses to get from source to destination.

router. (1) A computer that determines the path of network traffic flow. The path selection is made from several paths based on information obtained from specific protocols, algorithms that attempt to identify the shortest or best path, and other criteria such as metrics or protocol-specific destination addresses. (2) An attaching device that connects two LAN segments, which use similar or different architectures, at the reference model network layer. Contrast with *bridge* and *gateway*. (3) In OSI terminology, a function that determines a path by which an entity can be reached.

routing. (1) The assignment of the path by which a message is to reach its destination. (2) In SNA, the forwarding of a message unit along a particular path through a network, as determined by parameters carried in the message unit, such as the destination network address in a transmission header.

RSC. Remote Support Center.

RSF. Remote Support Facility.

RT. Real time.

S

s. Second.

SDH. Synchronous digital hierarchy.

SDLC. Synchronous Data Link Control.

SDT. Structured data transfer.

SF. Super Frame.

Serial Line Internet Protocol (SLIP). A TCP/IP protocol used on a point-to-point connection between two IP hosts over a serial line (for example, an RS/EIA-232 connection into a modem over a telephone line).

In an NBBS network, the SLIP is used over a connection between an Nways Switch administration station (NAS) and an IBM Network Support Center (NSC).

Simple Network Management Protocol (SNMP). In the Internet suite of protocols, a network management protocol that is used to monitor routers and attached networks. SNMP is an application layer protocol. Information on devices managed is defined and stored in the application's Management Information Base (MIB).

SLA. Serial link architecture.

SLIP. Serial Line Internet Protocol.

SNA. Systems Network Architecture.

SNMP. Simple Network Management Protocol.

socket. The abstraction provided by the University of California's Berkeley Software Distribution (commonly called Berkeley UNIX or BSD UNIX) that serves as an endpoint for communication between processes or applications.

source route bridging. In LANs, a bridging method that uses the routing information field in the IEEE 802.5 medium access control (MAC) header of a frame to determine which rings or token-ring segments the frame must transit. The routing information field is inserted into the MAC header by the source node. The information in the routing information field is derived from explorer packets generated by the source host.

spoofing. For data links, a technique in which a protocol initiated from an end station is acknowledged and processed by an intermediate node on behalf of the final destination. In IBM 6611 data link switching, for example, SNA frames are encapsulated into TCP/IP packets for transport across a non-SNA wide area network, unpacked by another IBM 6611, and passed to the final destination. A benefit of spoofing is the prevention of end-to-end session timeouts.

SRC. System reference code.

STM-1. Synchronous transport module-1.

SW. Switch (module).

SWRD. Switch redrive (module).

synchronous. (1) Pertaining to two or more processes that depend upon the occurrence of specific events such as common timing signals. (T) (2) Occurring with a regular or predictable time relationship.

Synchronous Data Link Control (SDLC). A discipline conforming to subsets of the Advanced Data Communication Control Procedures (ADCCP) of the American National Standards Institute (ANSI) and High-level Data

Link Control (HDLC) of the International Organization for Standardization, for managing synchronous, code-transparent, serial-by-bit information transfer over a link connection. Transmission exchanges may be duplex or half-duplex over switched or nonswitched links. The configuration of the link connection may be point-to-point, multipoint, or loop. (I) Contrast with *binary synchronous communication (BSC)*.

system. In data processing, a collection of people, machines, and methods organized to accomplish a set of specific functions. (I) (A)

Systems Network Architecture (SNA). The description of the logical structure, formats, protocols, and operational sequences for transmitting information units through, and controlling the configuration and operation of, networks. The layered structure of SNA allows the ultimate origins and destinations of information, that is, the end users, to be independent of and unaffected by the specific SNA network services and facilities used for information exchange.

T

TCP. Transmission Control Protocol.

TCP/IP. Transmission Control Protocol, Internet Protocol.

TDM. Time division multiplexing.

Telnet. In TCP/IP, an application protocol that allows a user at one site to access a remote system as if the user's display station were locally attached. Telnet uses the Transmission Control Protocol as the underlying protocol.

TFTP. Trivial File Transfer Protocol.

time division multiplexing (TDM). See *channelization*.

TN3270. An informally defined protocol for transmitting 3270 data streams over Telnet.

token. (1) In a local area network, the symbol of authority passed successively from one data station to another to indicate the station temporarily in control of the transmission medium. Each data station has an opportunity to acquire and use the token to control the medium. A token is a particular message or bit pattern that signifies permission to transmit. (T) (2) In LANs, a sequence of bits passed from one device to another along the transmission medium. When the token has data appended to it, it becomes a frame.

token ring. (1) According to IEEE 802.5, network technology that controls media access by passing a token (special packet or frame) between media-attached

stations. (2) A FDDI or IEEE 802.5 network with a ring topology that passes tokens from one attaching ring station (node) to another. (3) See also *local area network (LAN)*.

Transmission Control Protocol (TCP). A communications protocol used in Internet and in any network that follows the U.S. Department of Defense standards for internetwork protocol. TCP provides a reliable host-to-host protocol between hosts in packet-switched communications networks and in interconnected systems of such networks. It assumes that the Internet protocol is the underlying protocol.

Transmission Control Protocol/Internet Protocol (TCP/IP). A set of communications protocols that support peer-to-peer connectivity functions for both local and wide area networks.

Transmission Control Protocol/Internet Protocol (TCP/IP). A set of communication protocols that support peer-to-peer connectivity functions for both local and wide area networks.

transparent bridging. In LANs, a method for tying individual local area networks together through the medium access control (MAC) level. A transparent bridge stores the tables that contain MAC addresses so that frames seen by the bridge can be forwarded to another LAN if the tables indicate to do so.

Trivial File Transfer Protocol (TFTP). In the Internet suite of protocols, a protocol for file transfer that requires minimal overhead and minimal capability. TFTP uses the connectionless datagram delivery services of the User Datagram Protocol (UDP), which allows hosts that have no disk storage to implement TFTP in read-only memory (ROM) and use it to boot themselves.

U

UDP. User Datagram Protocol.

UNI. User network interface (protocol).

UTP. Unshielded twisted pair.

V

V ac. Volts alternating current.

V.24. In data communications, a specification of the CCITT that defines the list of definitions for interchange circuits between data terminal equipment (DTE) and data circuit-terminating equipment (DCE).

V.25. In data communications, a specification of the CCITT that defines the automatic answering equipment and parallel automatic calling equipment on the General Switched Telephone Network, including procedures for disabling of echo controlled devices for both manually and automatically established calls.

V.34. In data communications, an ITU-T standard model serial line protocol using signalling rates of up to 28 800 bps for use on the general switched telephone network and on leased point-to-point 2-wire telephone-type circuits.

V.35. In data communications, a specification of the CCITT that defines the list of definitions for interchange circuits between data terminal equipment (DTE) and data circuit-terminating equipment (DCE) at various data rates.

V.36. In data communications, a specification of the CCITT that defines the list of definitions for interchange circuits between data terminal equipment (DTE) and data circuit-terminating equipment (DCE) at rates of 48, 56, 64, or 72 kilobits per second.

version. A separately licensed program that usually has significant new code or new function.

virtual circuit. (1) In packet switching, the facilities provided by a network that give the appearance to the user of an actual connection. (T) See also *data circuit*. Contrast with *physical circuit*. (2) A logical connection established between two DTEs.

virtual connection. In frame relay, the return path of a potential connection.

VoFR. Voice over Frame Relay.

VPD. Vital product data.

W

WAN. Wide area network.

wide area network (WAN). (1) A network that provides communication services to a geographic area larger than that served by a local area network or a metropolitan area network, and that may use or provide public communication facilities. (T) (2) A data communications network designed to serve an area of hundreds or thousands of miles; for example, public and private packet-switching networks, and national telephone networks. Contrast with *local area network (LAN)* and *metropolitan area network (MAN)*.

X

X.21. An International Telegraph and Telephone Consultative Committee (CCITT) recommendation for a general-purpose interface between data terminal equipment and data circuit-terminating equipment for synchronous operations on a public data network.

X.25. An International Telegraph and Telephone Consultative Committee (CCITT) recommendation for the interface between data terminal equipment and packet-switched data networks. See also *packet switching*.

Index

A

- access
 - bootstrap menus 6-1
 - configuration program 6-1
- Access Integration Services software 4-1
- airflow 5-2

B

- bootstrap menus 6-1

C

- cables 2-12
- clearances, service 5-2
- compact flash storage 2-3
- configuration and monitoring tools 6-1
- configuration program 6-1

D

- dimensions of the IBM 2212 5-2

E

- environment, operating 5-2

F

- features
 - Network Dispatcher 1-11
 - Thin Server 1-8
 - TN3270E server 1-10
 - Virtual Private Networks (VPNs) 1-3
 - Voice integration 1-6
 - Voice over Frame Relay 1-6
 - Web Server Cache 1-9
- framing support 3-5

H

- hard drive storage 2-3
- hardware characteristics
 - airflow 5-2
 - clearances 5-2
 - dimensions 5-2
 - lightning 5-2
 - operating environment 5-2
 - power supply 5-3
 - weight 5-2
- hardware of the IBM 2212 6-1

- help ix

I

- IBM 2212
 - general multiprotocol routing 1-12
 - models 4-2
 - SNA transport 1-13
 - software 4-1
- integrated WAN ports 2-1, 2-6
- Internet resources ix, 4-2, 5-3, 5-7, 6-2, 7-5, 7-6
- IP-SNA integration 1-10
- ISDN
 - adapter planning 7-1
 - adapter support for 7-1
 - telephone line provisioning 7-1

L

- lightning protection 5-2
- load balancing 1-11

M

- models
 - determining which model to order 2-3, 4-2
- modem requirements 5-7
- monitoring and configuration tools 6-1

N

- network computing 1-8
- Network Dispatcher 1-11, 7-6
- network management 6-2
- network server 5-7
- network server storage 2-3
- networks supported 3-1

O

- OPCON 6-1
- operating environment of the IBM 2212 5-2
- options
 - 1-port 10/100-Mbps Ethernet PMC adapter 2-6
 - 1-port ISDN PRI E1 CPCI adapter 2-8
 - 1-port ISDN PRI T1/J1 CPCI adapter 2-7
 - 1-port Token-Ring PMC adapter 2-6
 - 2-port 10/100 Mbps CPCI Ethernet adapter 2-9
 - 2-port Analog E&M Voice/Fax CPCI 2-11
 - 2-port Analog FXO Voice/Fax CPCI 2-11
 - 2-port Analog FXS Voice/Fax CPCI 2-11
 - 2-port ISDN BRI-S/T CPCI adapter 2-7
 - 2-port ISDN BRI-U CPCI adapter 2-7

options (*continued*)

- 2-port ISDN PRI E1 CPCI adapter 2-8
- 2-port ISDN PRI T1/J1 CPCI adapter 2-8
- 2-port Token-Ring CPCI adapter 2-8
- 4-Port Analog 56K Modem CPCI 2-11
- 4-port WAN CPCI adapter 2-6
- cables 2-12
- Compression/Encryption CPCI Adapter 2-11
- E1 12 channel Digital Modem Adapter 2-10
- E1 30 channel Digital Modem Adapter 2-10
- T1/J1 12 channel Digital Modem Adapter 2-9
- T1/J1 24 channel Digital Modem Adapter 2-9

P

- physical characteristics of the IBM 2212 5-1
- power supply specifications 5-3
- protocol and feature support 3-4
 - bridging protocols 3-2
- IP
 - IPv4 3-2
 - IPv6 3-2
- network management protocols 3-2
- SNA/APPN protocols 3-2

R

- rack-shelf placement 5-1
- remote access 7-4
- replacing adapters 1-14

S

- service port hardware requirements 5-7
- service recovery interface 6-1
- software 4-1
- storage
 - compact flash 2-3
 - hard drive 2-3
 - network server 2-3

T

- table-top placement 5-1
- Thin Server 1-8, 7-5
- TN3270E server 1-10

U

- updates ix

V

- Virtual Private Networks (VPNs) 1-3, 7-6
- Voice integration 1-6
- Voice over Frame Relay 1-6

W

- Web Server Cache 1-9
- weight of the IBM 2212 5-2

Tell Us What You Think!

**2212 Access Utility
Introduction and Planning Guide
Publication No. GA27-4215-02**

We hope you find this publication useful, readable, and technically accurate, but only you can tell us! Your comments and suggestions will help us improve our technical publications. Please take a few minutes to let us know what you think by completing this form. If you are in the USA, you can mail this form postage free or fax it to us at 1-800-253-3520. Elsewhere, your local IBM branch office or representative will forward your comments or you may mail them directly to us.

Overall, how satisfied are you with the information in this book?	Satisfied	Dissatisfied
	<input type="checkbox"/>	<input type="checkbox"/>

How satisfied are you that the information in this book is:	Satisfied	Dissatisfied
Accurate	<input type="checkbox"/>	<input type="checkbox"/>
Complete	<input type="checkbox"/>	<input type="checkbox"/>
Easy to find	<input type="checkbox"/>	<input type="checkbox"/>
Easy to understand	<input type="checkbox"/>	<input type="checkbox"/>
Well organized	<input type="checkbox"/>	<input type="checkbox"/>
Applicable to your task	<input type="checkbox"/>	<input type="checkbox"/>

Specific comments or problems:

Please tell us how we can improve this book:

Thank you for your comments. If you would like a reply, provide the necessary information below.

Name

Address

Company or Organization

Phone No.



Fold and Tape

Please do not staple

Fold and Tape



NO POSTAGE
NECESSARY
IF MAILED IN THE
UNITED STATES

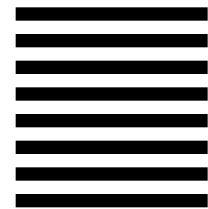

BUSINESS REPLY MAIL

FIRST-CLASS MAIL PERMIT NO. 40 ARMONK, NEW YORK

POSTAGE WILL BE PAID BY ADDRESSEE

Design & Information Development
Dept. CGF/Bldg. 656
International Business Machines Corporation
PO BOX 12195
RESEARCH TRIANGLE PARK NC 27709-9990



Fold and Tape

Please do not staple

Fold and Tape



Part Number: 30L6112



Printed in the United States of America
on recycled paper containing 10%
recovered post-consumer fiber.

Web sites:

2212 Documentation

www.ibm.com/networking/support/docs.nsf/2212docs

2212 Software Updates

www.ibm.com/networking/support/downloads/2212

2212 Product Support

www.ibm.com/networking/support/2212

Networking Product Sales

www.ibm.com/networking

Networking Product Support

www.ibm.com/networking/support

